

MOISTURE PROBLEMS IN MANUFACTURED HOMES UNDERSTANDING THEIR CAUSES AND FINDING SOLUTIONS

Excellence in Design,
Manufacturing and Installation Series



Moisture Problem Checklists

Moisture Problem Prevention

Moisture Problem Mitigation

Moisture Problem Basics

MOISTURE PROBLEMS IN MANUFACTURED HOMES UNDERSTANDING THEIR CAUSES AND FINDING SOLUTIONS

Excellence in Design,
Manufacturing and Installation Series



Acknowledgements

The Manufactured Housing Research Alliance wishes to acknowledge the assistance, advice, and guidance of a number of people without whose help the publication of this guide would not have been possible.

The dynamics of moisture flow in buildings is well understood yet the circumstances that will result in moisture-related problems are often difficult to predict, but when understood, possible to avoid. We use the term "moisture problems" to capture a whole array of different types of building failures that may have multiple sources, occur in different seasons of the year and geographical locations, and result from decisions made by manufacturers, installers, homeowners or some combination of the three. Weaving together a clear and concise resource guide on this complex topic was a task requiring many perspectives and a wide breadth of practical experience.

The effort was lead by a project Steering Committee consisting of the following members:

Richard Christjansen, *Johns Manville Corporation*, Project Chair
Subrato Chandra, *Florida Solar Energy Center*
Bob Davis, *Ecotope*
Andre Desjarlais, *Oak Ridge National Laboratory*
Mark Ezzo, *Oakwood Homes Corporation*
William Farish, *Fleetwood Enterprises, Inc.*
William Freeborne, *US Department of Housing and Urban Development*
John Freeman, *Friedrich Air Conditioning Company*
William Harker, *TACC International*
George James, *US Department of Energy*
Frank Kern, *Heatilator*
Bert Kessler, *Palm Harbor Homes*
Rob Luter, *Ventline, Inc.*
Mike Lubliner, *Washington State University Energy Program*
Mike Kinard, *Kinro, Inc.*
Mike McKittrick, *International Paper*
Neil Moyer, *Florida Solar Energy Center*
Armin Rudd, *Building Science Corporation*
Dwight Schuler, *Owens Corning*
Richard Veenstra, *Fleetwood Enterprises, Inc.*
Andrea Vrankar, *US Department of Housing and Urban Development*
Frank Walter, *Manufactured Housing Institute*
Bill Warren, *AirTech Solutions*
James Welz, *Philips Products*
Paul Ziegler, *National Council of States on Building Codes and Standards*
Mike Zieman, *RADCO*

Design, production, and editorial subcontractors:

Hoi Ling Chu, *H. L. Chu and Co.* (Graphic Design)
Dorothy Foster, *Pacific Consulting Services* (Editing)
Robert La Pointe (Illustrations)

MHRA staff responsible for coordinating and facilitating the development of the guide:

Emanuel Levy, Executive Director
Francis Conlin, Project Coordinator
Sandra Ho, Editorial Director

Disclaimer

The Manufactured Housing Research Alliance, its members, consultants, contractors and representatives make no representations, warranty or guarantee, express or implied, as to the accuracy or appropriateness of any materials or information in this manual for use in a specific home, nor assume any liability for the use of the information, methods, or materials contained herein, or for damages arising from any such use.

CONTENTS

List of Illustrations	v	
Chapter 1	Introduction	1.1
		1.2
		1.3
		1.4
Chapter 2	Moisture Problem Prevention	2.1
		2.2
		2.8
		2.11
Chapter 3	Moisture Problem Mitigation	3.1
		3.1
		3.5
		3.12
		3.15
		3.17
		3.19
		3.21
		3.22
Chapter 4	Moisture Problem Basics	4.1
		4.1
		4.3
		4.5
		4.6
Appendix A	Glossary	A.1
Appendix B	Bibliography	B.1

LIST OF ILLUSTRATIONS

Figure	Page
2.1 Moisture Problems by Region of Country	2.1
2.2 Avoid Compressing Insulation	2.4
2.3 Make Airtight, Durable Duct Connections	2.6
2.4 Seal All Penetrations Through the Floor	2.7
2.5 Site Grading Practices to Avoid	2.9
3.1 Floor Perimeter Stain	3.2
3.2 Bump in the Floor	3.3
3.3 Bulge in the Belly	3.4
3.4 Interior Wall Filled With Outside Air	3.6
3.5 Vapor Retarder on Wrong Side	3.7
3.6 Misplaced Window Flashing	3.8
3.7 Condensation Between Glass Panes	3.9
3.8 Water on Windows	3.10
3.9 Frozen Walls	3.11
3.10 Ice Dam	3.13
3.11 Attic Condensation	3.14
3.12 Clogged Filter	3.16
3.13 Crawlspace Moisture Control and Ventilation	3.17
3.14 Raining in the Crawlspace	3.18
3.15 Flooded Ducts	3.20
3.16 Water in Crossover Duct Insulation	3.21
3.17 Closed-Off Room	3.23
4.1 Moisture Balance	4.1
4.2 Moisture Production From Indoor Activities	4.2
4.3 Sources of Moisture	4.3
4.4 Moisture Movement	4.4
4.5 Moisture Accumulation	4.5

INTRODUCTION

The demands of the housing marketplace today challenge the home building and manufacturing industry to offer more and more features and increasingly better quality. Each element added and each improvement made in home design, installation, and operation has an impact on overall home performance, including the moisture balance within the home and its building components. When new designs are introduced without consideration for the effect on moisture dynamics, conditions are prime for water to accumulate and cause damage.

This manual is designed to assist manufacturers, retailers, setup crews, and homeowners to recognize and solve moisture problems in manufactured homes. It reviews the symptoms of typical problems, outlines preventive measures, and provides solutions pertinent to home design, manufacture, installation, operation, and maintenance.

A home's ability to resist potential moisture problems is a result of many decisions made at different stages of the home's life. Chapter 2 describes actions that can be taken during home design and construction, installation, and operation to prevent moisture-related problems. To provide a real-world perspective, Chapter 3 includes examples of homes experiencing moisture-related damage. The examples document why moisture problems occur and how they can be avoided. They are organized by the predominant location of the symptoms: floors, walls, ceiling, heating and cooling systems, and the crawlspace (or whole house). It is intended that users of this manual will first identify where their symptom is located, and then use this manual to review similar problems at the same site. Chapter 4 reviews the basic building blocks of a moisture problem: moisture source, transport mechanism, and accumulation site characteristics. This manual does not attempt to include all of the many specific and detailed moisture problems that have faced the industry; rather it is intended to be a snapshot of the more common types of moisture problems existing in current manufactured housing. Many published texts describe in greater detail the physics of moisture dynamics in residential buildings. Readers interested in learning more about the subject are encouraged to explore the materials listed in the bibliography.

A manual specific to moisture problems in manufactured housing is necessary because of the differences between factory-built and site-built housing. Manufactured homes must comply with the provisions of the Manufactured Home Construction and Safety Standards¹, a set of regulations administered by the US Department of Housing and Urban Development (HUD). The HUD standards represent a national building code for manufactured housing and sometimes specify construction details that are unique to manufactured housing.

Some of the design characteristics more commonly found in manufactured homes create the need for special approaches to moisture control:

- Homes are built in one or more sections in manufacturing plants using assembly line construction methods and materials not found in site-built homes.
- Home sections are built on steel frames with wheels and have an integrated floor system design that is enclosed with a plastic cover, called bottom board.
- Homes from the same manufacturing plant can be shipped to a number of destinations and experience a wide range of temperature and humidity conditions at their final locations.
- Home sections are designed to be installed quickly on site. Perimeter skirting and protection from ground moisture may or may not be added later.

These features have implications for the development of moisture problems and several are clearly associated with problems experienced by owners of manufactured housing. The relevant precautions can be as simple as ensuring adequate weather protection for a home during transport and setup. Over the past few decades, however, less obvious and more challenging moisture issues involving condensation and indoor air quality have surfaced in all types of homes. Many of these problems center on condensation-induced structural damage (such as buckled floors) or fungal growths (molds and mildew) found within framing cavities and on home surfaces, furnishings, and other homeowner belongings. This manual covers the range of potential moisture-related problems known to occur in manufactured homes to give readers a comprehensive guide to their prevention and remedy.

¹ Part 3280, Manufactured Home Construction and Safety Standards and Interpretative Bulletins to the Standards, US Department of Housing and Urban Development (April 1999)

THE MANUFACTURER'S CHECKLIST



Minimize ceiling penetrations

Unless tightly sealed, penetrations in the ceiling are natural pathways for moisture vapor migration, resulting in condensation and mold in the attic cavity. Warm air entering the attic can also melt snow on the outer surface of the roof and cause water leaks from ice damming.



In hot, humid climates, avoid placing a vapor retarder on the inside of the wall

If the vapor retarder is on the cool side of the wall insulation, water vapor that migrates into the wall cavity can condense inside the wall and become trapped. The inside covering of an exterior wall in hot, humid climates should have enough permeability to allow trapped vapor to diffuse into the living area.²



Insulate the outside walls and ceiling without voids or compression

Voids and compressed insulation, especially near the top plate and outside wall corners, result in cold spots that encourage condensation and mold growth.



Reduce opportunities for air leakage through the walls

The uncontrolled movement of air through the walls leads to the reduction in thermal efficiency, cold spot on building surfaces, and water vapor migration into the home. Proper sealing of all penetrations and the application of an effective exterior air retarder are good strategies for reducing the entry of unconditioned outdoor air entering the home.



Recommend properly sized cooling equipment and climate appropriate ventilation

Oversized cooling equipment (air conditioners and heat pumps) cycles on and off frequently, doing a poor job of removing moisture from the air. Excess ventilation in humid climates can overwhelm the dehumidification capacity of the air conditioning equipment.



Carefully plan the air supply and return registers

Ensure adequate register size, avoid locating registers near sources of water, and don't place supply registers where they are likely to be covered by furniture or otherwise blocked. Provide for adequate return air transfers from bedrooms, especially master bedroom suites.



Seal ducts to make airtight, durable connections

Leaky ducts can substantially increase the amount of outside air that enters a home, adding to the space conditioning load and increasing opportunities for moisture problems. Joints in the ducts and connections to the furnace should be sealed with mastic (preferable) or properly applied tape (less effective) to make durable and leak-proof seals.



Specify production details that minimize moisture damage

Attention to detail is the most important measure that can be taken during home construction to avoid moisture problems. No matter how well engineered a design is for moisture control, it can be defeated by incorrect installation of materials.



Specify plant installation of items that minimize setup errors

The marriage line gasket, utility connections, and other items can easily and more effectively be installed at the plant, where quality is easier to control.

² As this Guide goes to press, the HUD Manufactured Housing Construction and Safety Standards require that the vapor retarder be located on the interior side of the wall in all locations. However, HUD is considering issuing a waiver that would allow the vapor retarder to be located on the outside of the wall insulation for hot, humid climates.

THE INSTALLER'S AND HVAC CONTRACTOR'S CHECKLIST

-  **Make sure the site is properly graded to shed water**

Inspect the site before the home is delivered. Water draining under a home can destabilize the foundation as well as increase the chance of moisture migrating into the house.
-  **Seal the marriage line completely**

A non-porous gasket should be placed along the inside edge of the insulation in a continuous "ring" to prevent air and water vapor from infiltrating into the home and wall cavities. Consider also installing an air retarder along the wall seams.
-  **Install a ground cover**

Installation of a ground cover is one of the most overlooked and underestimated setup tasks. Water vapor from the ground is often the largest source of moisture load on a house.
-  **Ensure that any tears or gaps in the bottom board material are durably sealed**

Water vapor from the ground will find its way into the floor cavity through tears in the bottom board, adding to the house moisture load and condensing on cold surfaces such as air conditioning ducts.
-  **Leave no metal surfaces exposed when installing the crossover duct**

When the air conditioner is operating, metal duct exposed to the crawlspace will become cold and condense moisture from the air. Be sure ducts and metal boxes are off the ground, connected securely, sealed tight, and completely insulated.
-  **Make sure the dryer exhaust duct is supported and installed correctly**

Like a drainpipe, the dryer exhaust duct needs to slope downhill and have proper support. Water can easily condense inside this duct, blocking airflow, tearing the duct, and allowing delivery of moist dryer exhaust under the home.
-  **Properly size cooling equipment and, in humid climates, recommend equipment with higher latent removal capacity**

Cooling equipment should be sized to closely match the design load. If the equipment is already installed and has a large overcapacity for the load, set the blower as low as 350 cfm per ton of cooling capacity to increase dehumidification.
-  **Make sure the air conditioner condensate line is properly trapped and terminates outside of the skirting**

An improperly trapped line will not function properly: air will be drawn in through the condensate line and prevent drainage; condensate water will overflow onto the floor, often resulting in damage under the air handler.

THE HOMEOWNER'S CHECKLIST



Eliminate moisture problems at the source

Many moisture problems begin with excess amounts of water dumped into the air by common household activities, such as cooking and bathing. Ventilation fans should be turned on during such activities. They should be left on for a short time after the moisture producing activity ceases.



When it comes to the size of your air conditioner or heat pump, bigger is not better

Air conditioners and heat pumps should be sized to meet the cooling needs of your home. Equipment that is too large will turn on and off frequently, allowing humidity to build up indoors.



Do not use unvented propane, kerosene, or other unvented combustion heaters

About a gallon of water vapor is released into the air for every gallon of fuel consumed. This is a significant source of water vapor that can quickly cause damage. Some unvented heaters can also increase pollutant levels and contribute to health problems.



Do not cover or close off the floor registers

In many homes, air from the heater or air conditioner is distributed through registers in the floor. Covering these registers with furniture or rugs can imbalance the system and create cold spots on room surfaces, increasing the potential for moisture condensation.



Check your cooling equipment filter monthly

Clogged filters can interfere with an air conditioner's ability to remove moisture from the air, and in some cases interfere with condensate drainage. Dirty filters should be either cleaned or replaced. Consider using pleated filters for better dust control and better dehumidification.



Keep the thermostat set above 75°F in hot, humid climates

Keep the thermostat setting at or above 75°F in the summer. In high humidity climates, a lower setting could cause water to condense inside wall cavities.



Recognize signs of moisture problems

Big moisture problems start as small ones, and any moisture problem is more easily cured if discovered early on. The following are warning signs of possible moisture problems: persistent musty smells; discoloration on walls or ceilings; swelling of floor, wall, or ceiling finishes; condensation on window glass; or standing water under your home.

MOISTURE PROBLEM PREVENTION

Moisture, as liquid and vapor, is an integral part of daily life—we breath it, drink it, bathe in it, and use it for growing foods. We don't often think of it as a part of or a potential problem in housing.

Most homes do an excellent job of keeping moisture in check. As a result, moisture-related problems are relatively rare. There is new anecdotal evidence, however, that moisture-driven problems are occurring with greater frequency in new homes, particularly in the hot, humid areas of the nation.

However, moisture problems occur in all climates and different regions are prone to different types of problems. The climate region dictates the level of heating or cooling needed, and the degree of outdoor humidity. **Figure 2.1** shows average humidity levels across the United States. The areas with high outdoor humidity are known for summertime moisture condensation problems. The map also shows the cooler areas of the country most prone to wintertime moisture condensation problems.

Figure 2.1 Moisture Problems by Region of Country

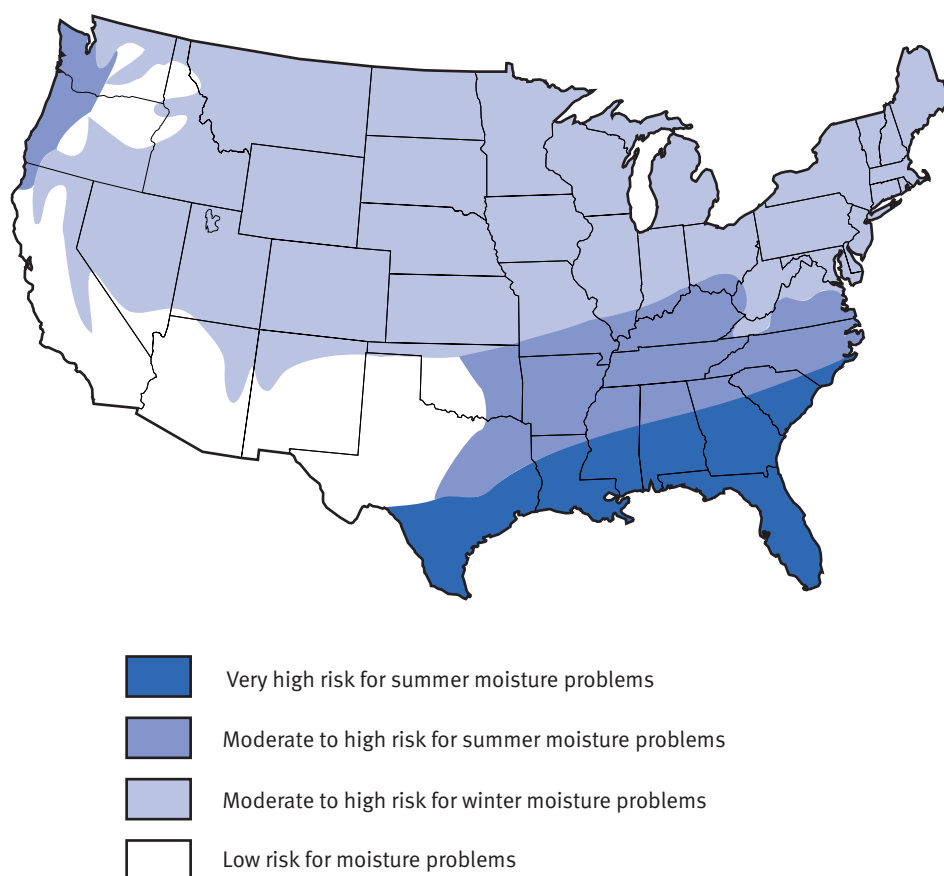

The problems common in homes in Northern regions are typically the result of cold temperatures from outdoors mixing with water vapor generated inside the home, causing condensation. In the South, the problem is reversed: the cold conditions are created by air conditioning, and the moisture source is typically humid outdoor air. Whenever humid outdoor air meets building materials cooled by air conditioning, condensation is possible. In both the Southeast and Northeast, outdoor humidity can be high long enough to significantly slow drying. In these climates, materials stay wetter longer and are more subject to rot and other types of decay. Local climates also can subject a home to water damage from driven rain, extreme humidity, and flooding.

Most building materials can tolerate occasional wetting—as long as they also have ample exposure to dryer air, which will act to dry them out. Sometimes, however, circumstances prevent drying and cause moisture to build up to amounts that can damage a home. When damage does occur, it can be difficult to diagnose and expensive to

repair. Extreme moisture problems can degrade material properties, such as strength and insulating capacity, support the growth of rot, mold, and rust, and increase the weight of building materials beyond the capacity of supporting structures. Although such moisture-related catastrophic damage in homes is rare, smaller problems such as mold growth or uncomfortable humidity are more common.

The best approach for avoiding moisture-related problems is to take steps to prevent excessive moisture buildup from occurring. There are multiple opportunities over the life of a home to take actions that minimize the potential for moisture accumulation. This chapter describes precautions that can be taken at the stages of home design and construction, home installation, and home operation.

AVOIDING PROBLEMS THROUGH DESIGN AND CONSTRUCTION

The first place to take precautions against moisture problems is on the drawing board. Understanding the principles of moisture dynamics is essential to developing a building plan for a home free of moisture problems. A good design considers interior and exterior moisture sources, all possible moisture transport methods, and the various potential moisture accumulation sites. A comprehensive solution must also account for climate and other region-specific concerns. If all of these issues are factored into a design, the resulting home is much less likely to experience moisture problems and will dry out more readily if moisture accumulation does occur.

Taking extra measures in design can significantly minimize risk—at relatively little added cost. The basic measures involve limited use of ceiling penetrations, use of climate-appropriate vapor retarders and ventilation systems, careful installation of insulation, control of air leakage, appropriate planning of duct supplies and returns, correct sizing of air conditioning equipment, and provision of comprehensive setup materials and instructions.

Attention to detail during home construction is also important to avoid moisture problems. No matter how well engineered a design is for moisture control, it can be defeated by incorrect installation of materials. Production crews are easily tempted to make assumptions about the function of certain construction elements and to then take uninformed shortcuts in construction. Such shortcuts ignore the fact that, as part of a complex system, any specific construction element may serve functions other than those immediately obvious. Periodic employee training and reinforcement is essential to keep staff on target and informed about new materials and techniques. Although the in-house and third-party inspection system helps to detect construction faults that may lead to problems, inspectors too can overlook or be unaware of details important to moisture control.

Minimize ceiling penetrations

Unless tightly sealed, penetrations in the ceiling are natural pathways for moisture vapor migration, resulting in condensation and mold in the attic cavity. Warm air entering the attic can also melt snow on the outer surface of a roof and cause water leaks from ice damming.

Water vapor and heat moving up through the ceiling and accumulating in the attic space can result in moisture problems. Although the manufactured housing standards specify use of a ceiling vapor retarder in colder zones (HUD Thermal Zones 2 and 3), this moisture control strategy addresses only vapor that moves by diffusion. Holes in the ceiling provide a pathway for air to infiltrate into the attic from the living space. The forces that drive air into the attic include stack effect and pressure imbalances caused by ventilation equipment, leaky ducts, poorly balanced air distribution systems, and insufficient return air pathways.

Ceilings in manufactured housing are initially relatively airtight. In the plant, most ceilings begin as a monolithic construction without perforations. All of the ceiling panel intersections are sealed, which is all that is required to prevent air movement into the attic space. The attic space is also protected in some climates by vapor retarders on the ceiling that are often applied as paint; these have good reliability in minimizing vapor diffusion in winter-dominated climates. Ceiling sections that rely on faced attic insulation for a vapor retarder are less protected from diffused water vapor. In summer-dominated climates, a vapor barrier on the inside of a ceiling can increase the risk of

moisture accumulation in the ceiling material. Stain blocking paint is a vapor barrier, and covering stains with such paint can make the problem worse if it is caused by condensation within the building cavity.

The attic spaces in double-section manufactured homes are usually ventilated, increasing the potential for drying and reducing the risk of moisture damage in cold climates. However, attic ventilation may not be effective in drying out significant localized accumulations that can occur when moist air is transported through ceiling perforations. Single-section homes with metal roofs are not required to have ventilated attics; thus, careful sealing of all penetrations from the living space to the attic cavity is important in these homes.

The installation of lights, vents, complex ceiling designs and other items necessitates puncturing the ceiling many times. Care must be taken to seal ventilation fans, recessed canned lights, intercom speakers, ceiling duct diffusers, jumper ducts, and all electrical cables that run into the attic. Properly applied caulk, foam, or gasket seals are airtight and durable. Surface-mounted electrical boxes, when appropriate, are easier to seal than recessed boxes. Make sure recessed light fixtures are both suitable for "insulation contact" (IC-rated) and performance-tested to minimize air leakage into the attic space.

In hot, humid climates, avoid placing a vapor retarder on the inside of the wall insulation

If a vapor retarder is on the cool side of the wall insulation, water vapor that migrates into the wall cavity can condense inside the wall and become trapped. The inside covering of an exterior wall in hot, humid climates should have enough permeability to allow trapped vapor to diffuse into the living area.

Use of interior vapor retarders is problematic in hot, humid climates. Experts in building moisture control advise against exterior walls with a vapor retarder on the inside in hot, humid regions, particularly when combined with a permeable surface on the outside. Vinyl-covered wall board has a particularly low permeability rating on its interior surface and has been implicated in a number of recent significant wall failures in the hot, humid Gulf Coast states. Use of vinyl wall board particularly should be avoided for homes where outside air can easily penetrate beneath the exterior siding into the wall cavity. Although this is a relatively common practice, and is allowed under the manufactured housing building standards, the recent increase in reported failures of this wall system provides ample reason for reconsidering this approach.

Building systems tend to be forgiving of moisture accumulation and dry out if given the opportunity. Indeed, there are many homes in humid regions in which the vinyl-covered wall board has not failed. However, with vinyl, the wall is more likely to be near a critical threshold for failure and small changes in design, construction, operation, or the local climate can create moisture problems.

Insulate the outside walls and ceiling without voids or compression

Voids and compressed insulation, especially near the top plate and outside wall corners, result in cold spots that encourage condensation and mold growth.

Insulating the cavity spaces within walls and ceilings is relatively easy. Insulating around all of the details and framing components is more challenging but just as important for moisture control. During the winter, these components conduct heat faster to the outdoors and become the site of cold spots that support growth of mold and mildew. Avoid excess wall framing material, which has less insulating value, particularly in corners, headers, and top and bottom plates. It is also important to allow the insulation to expand to its full thickness and avoid compressing the insulation with wires and other materials placed in the exterior walls. The ceiling near the soffit edge is at increased risk because space limits the amount of insulation that can be placed there. Insulation should be placed up against the edge baffles at the heel of the attic truss (used to keep an attic ventilation path open). Insulation should completely fill wall cavities, leaving no voids for convection.

In the floor, outrigger sections are often the site of insulation compression. Here it is important to install the insulation blanket in a way that relieves the otherwise compressed insulation. Additional batt insulation in outrigger cavities helps minimize the potential for cold spots and mold on the floor and carpet above.

Figure 2.2 Avoid Compressing Insulation

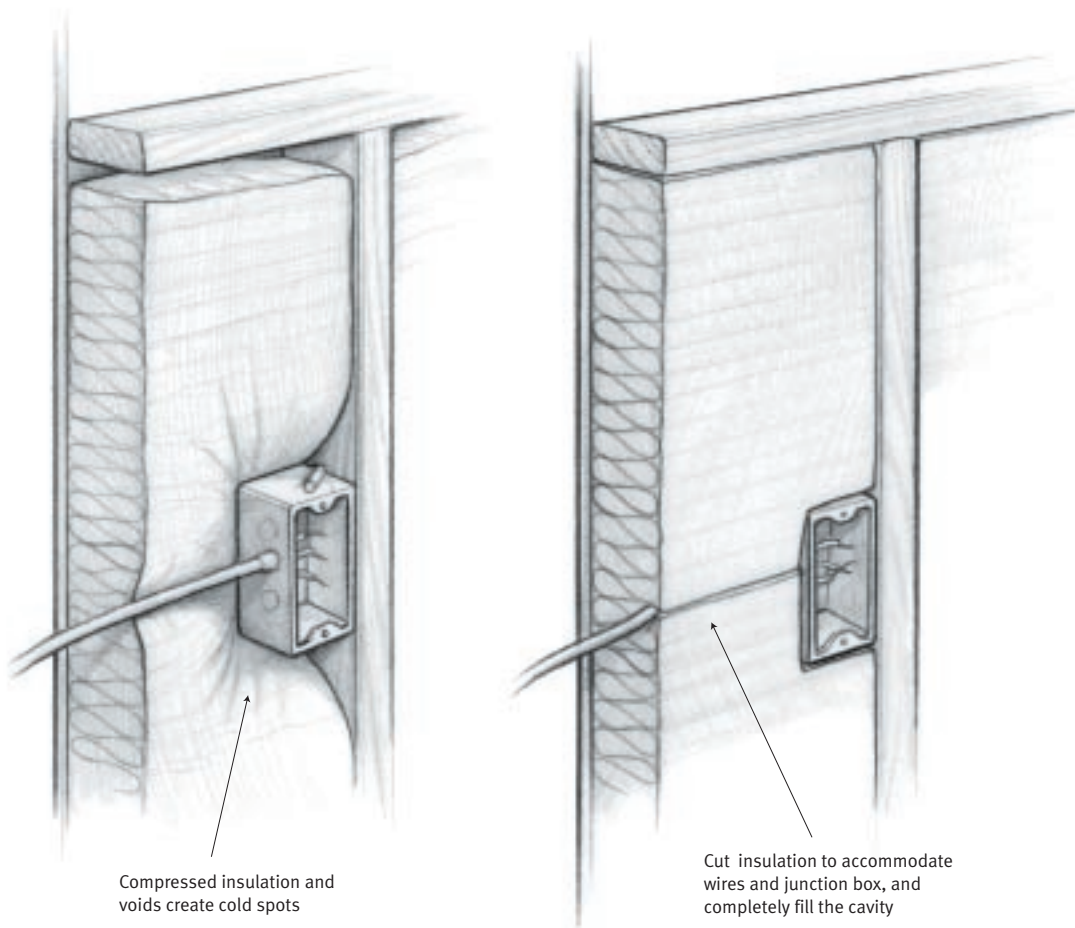

Compressing the insulation with wires and other material placed in the exterior walls will create cold spots on the inside wall covering (left). Cut insulation to fit around junction boxes and to completely fill the cavity (right).

Reduce opportunities for air leakage through the walls

The uncontrolled movement of air through the walls leads to a reduction in thermal efficiency, cold spots on building surfaces, and water vapor migration into the home. Proper sealing of all penetrations and the application of an effective exterior air retarder are good strategies for reducing the entry of unconditioned outdoor air into the home.

Most exterior sidings allow for normal expansion and contraction from either moisture or heat. Material movement and the normal seams in the siding materials provide an entry point for air that can bring in both liquid water and humidity-laden air that may condense in the wall cavities. Small openings in the electrical outlets, switch plates, floor-to-wall and wall-to-ceiling interfaces offer pathways for air and the moisture it holds to migrate through the walls. The use of caulk, tape, and air retarders will reduce this unwanted air leakage.

Recommend properly sized cooling equipment and climate-appropriate ventilation

Oversized cooling equipment (air conditioners and heat pumps) cycles off frequently, doing a poor job of removing moisture from the air. Excess ventilation in humid climates can overwhelm the dehumidification capacity of the air conditioning equipment.

Oversizing of air conditioners is a common practice that results in high indoor humidity. Dehumidification from air conditioning is a function of how long the equipment runs; and oversized equipment cools the air quickly but does not run long enough to provide significant indoor dehumidification. Homeowners often respond by lowering the thermostat set point, decreasing the temperature. The resulting high humidity can lead to mold, and colder temperatures increase the potential for damaging condensation.³

Ventilation is part of a good heating, ventilating, and air conditioning (HVAC) design. Ventilation in humid climates should be carefully planned so that it doesn't add significant moisture to a home. At minimum, ventilation air should pass through the air conditioner dehumidification coils before being distributed through the home.

Carefully plan the air supply and return registers

Ensure adequate register size, avoid locating registers near sources of water, and don't place supply registers where they are likely to be covered by furniture or otherwise blocked. Provide for adequate return air transfers from bedrooms, especially master bedroom suites.

The air distribution system design should ensure that bathroom and kitchen air supply ductwork is installed at locations and elevations that minimize their chance of being flooded with spilled water. It is best to locate bathroom ducts off the floor so they are unaffected if water overflows a tub, toilet, or sink. Molds and bacteria grow well in moist duct (particularly in the warm air of the heating season). A flooded duct can readily overwhelm the dehumidification capacity of an air conditioner, raising the relative humidity of the conditioned air and initiating mold growth throughout a home.

Air supply, rather than flooding, is the key consideration when locating supply registers in other parts of a home. The home design should place these registers where they are unlikely to be obstructed by furniture or drapes. Proper distribution of air is needed to assure an even distribution of heated or cooled air throughout a home. Blocked or poorly located supply registers result in wintertime cold spots that encourage mold. Equally important is adequate return air provision. Deficient return air, often caused by door closures, will cause negative pressures in portions of the home that will bring in unconditioned outdoor air.

Providing adequate return air paths from all rooms separated from the HVAC equipment by a door is also critical. Avoid placement of HVAC equipment within a utility room that is separated from the remainder of the home by a solid door. Ventilation air that is supplied directly to the air handler cabinet and bypasses the cooling/dehumidification coils, may add too much moisture in humid climates.

Seal ducts to make airtight, durable connections

Leaky ducts can substantially increase the amount of outside air that enters a home, adding to the space conditioning load and increasing opportunities for moisture problems. Joints in the ducts and connections to the furnace should be sealed with mastic (preferable) or properly applied tape (less effective) to make durable and leak-proof seals.

Air that leaks from ducts is replaced with unconditioned air infiltrating from the outside. In humid climates such infiltration can substantially increase the amount of water vapor that enters a home, both adding to the cooling load and increasing opportunities for moisture problems. Properly sealed ducts help keep a home pressure-balanced to minimize infiltration. Uninsulated duct and materials that have been cooled by duct leakage will result in cold materials in the floor cavity that can condense moisture out of the air. This moisture may be absorbed by the surrounding materials, causing them to swell or drip into the belly cavity where chances of re-evaporation are limited.

³ The Manufactured Housing Research Alliance (MHRA) has published state-specific guidelines for properly sizing cooling equipment. The *Manufactured Home Cooling Equipment Sizing Charts* are available from MHRA.

Figure 2.3 Make Airtight, Durable Duct Connections

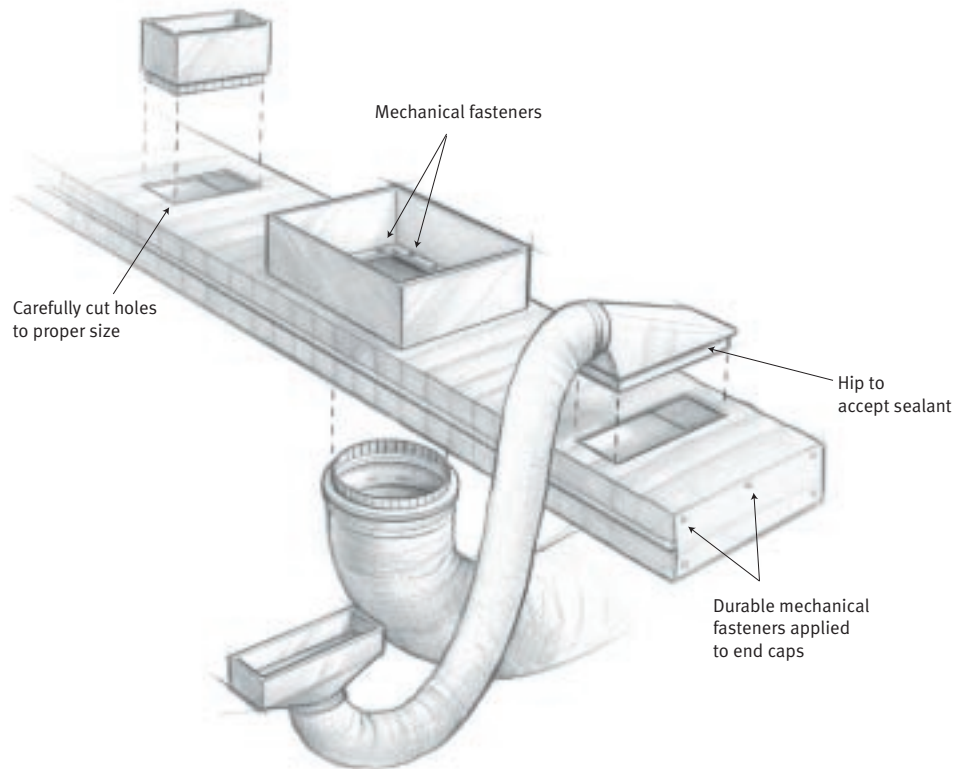

Leaky ducts increase the chance of moisture problems. To make airtight connections, cut accurate holes in the trunk, use boots and collars with a hip to accept sealant, and mechanically fasten connections.

Specify production details that minimize moisture damage

Attention to detail is the most important measure that can be taken during home construction to avoid moisture problems. No matter how well engineered a design is for moisture control, it can be defeated by incorrect installation of materials.

Install window, wall, and roof flashing details according to the manufacturer's specifications. Flashing and building paper not only prevents any rain that streams down a window or roof from entering a home, but also protects the interior cavities against water that is driven uphill by wind or capillary action. Capillary action between adjacent materials can bring water uphill several inches. Likewise, holes drilled in the outside wall for installation of light fixtures and windows must be properly sealed with caulk or a durable gasket to prevent rainwater from draining or being sucked into the wall cavity when the home is under negative pressure.

Create effective, durable seals to stop air and water vapor movement. Sealing cracks and holes with caulk, foam, or gaskets is part of an overall home design, but a seal's performance depends on how well the seal is made. It takes only a small imperfection in a seal to cause a significant failure. For example, a small gap in the seal joining a tub enclosure to the floor can allow gallons of spilled water to drain into the floor cavity. In a site-built home, the water would drain out of the floor system with potentially little repercussion, but in a manufactured home, the bottom board will retain this water for a long period of time. Overlooking this small detail in construction can cause significant damage. It is similarly important to seal penetrations into the ceiling cavity, including those made by electrical wiring.

Patch access holes in the belly material. Repairs made to the bottom board should include both mechanical fastening and a flexible sealant that will set up to resist moisture transport as well as cover the hole in the original belly material. Holes in the bottom board that are not sealed or that quickly fail invite water vapor from the damp crawl-space into the floor cavity. The best bottom board repair technique is to place sheathing material within the belly

above the hole, mechanically fasten the torn belly to the sheathing, apply a sealant—mastic, silicon, or adhesive—to the tear, cover the outside of the tear with scrap belly material or sheathing, and fasten this piece to the sheathing within the belly with staples or screws. Bottom board repairs made in the plant should set an exemplary standard and be the model for work in the field by the setup crew.

Figure 2.4 Seal All Penetrations Through the Floor

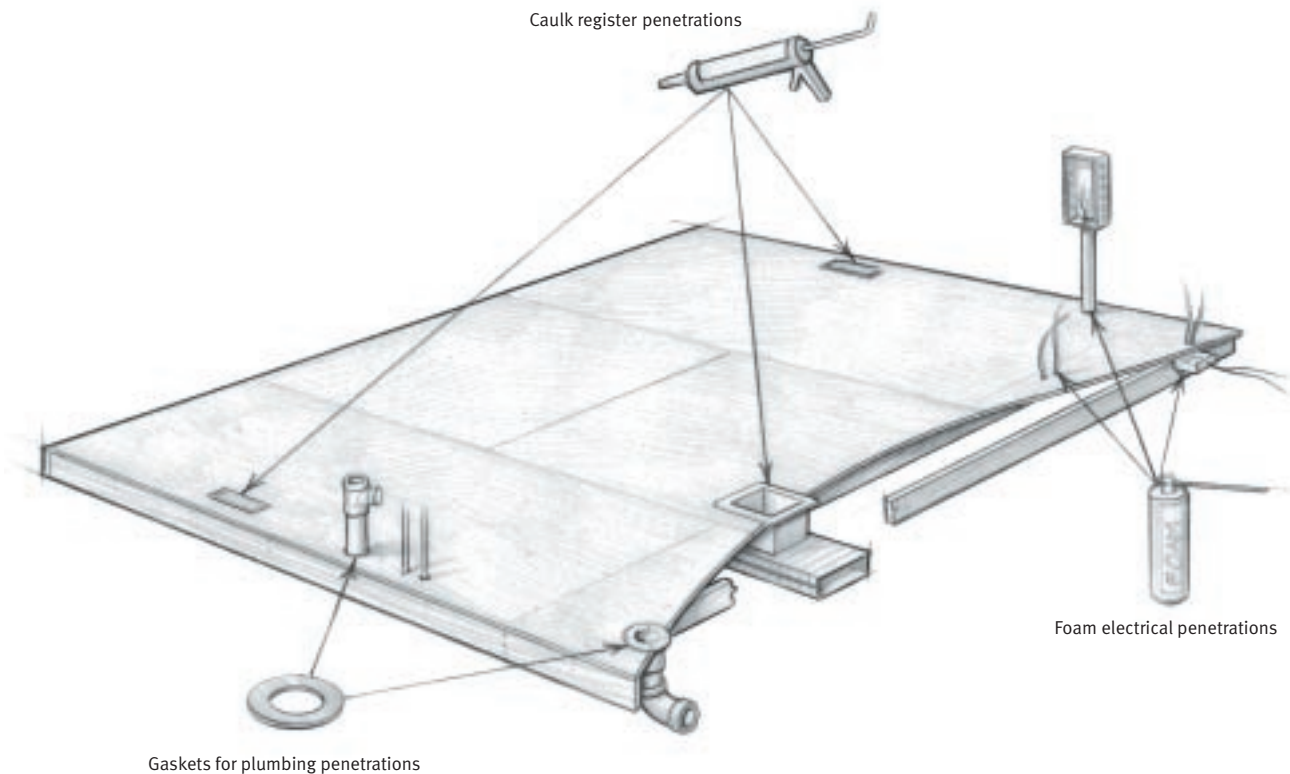

The floor is a natural moisture and air barrier. Keep it intact by sealing all floor penetrations with the appropriate sealant or gasket.

Specify plant installation of items that minimize setup errors

The marriage line gasket, utility connections, and other items can easily and more effectively be installed at the plant—where quality is easier to control.

Installation quality influences the moisture balance of a home. Unfortunately, proper setup remains one of the biggest challenges facing the manufactured housing industry. A home manufacturer can circumvent several problems by taking responsibility for some of the installation tasks traditionally conducted during installation:

- Specify installation of the marriage line gasket in the plant to avoid misalignment or use of inferior gasket materials by setup crews.
- Include setup materials with the home. Once on-site, if the proper materials are not available, the crew will often simply do the best they can with the materials on hand.
- Specify adequate telephone and cable terminals for prewiring and provide a dedicated outside service connection. This will eliminate the need for installers to make holes in the bottom board.
- Specify above-floor connections for electrical, plumbing, and other systems to minimize penetrations through the bottom board.
- Specify plant installation of the dryer exhaust vent and ensure it terminates outside of the home. If possible, route the exhaust duct inside the belly, above the insulation, to prevent condensation and to provide good support.

AVOIDING PROBLEMS THROUGH SETUP

Even though manufactured homes are principally built in a factory, there is a considerable amount of work for the on-site installation crews that will impact a home's moisture balance. Installation crews range from independent contractors to factory employees and may include both career setup professionals and unskilled laborers. Setup determines the final quality of a home, ensuring either comfort, durability, and efficiency or discomfort, high-energy costs, and moisture problems. Quality home installation has been cited as the biggest challenge facing the manufactured housing industry; however, due to increased awareness and efforts by many professionals, improvements are already in evidence.

Setup is a difficult task. It is dirty, dangerous, and demanding. Completion deadlines often require intimate knowledge of several manufacturers' installation instructions; work in confined spaces; and a knack for simultaneously satisfying manufacturers, retailers, state inspectors, and homeowners. Just as in manufacture, a poor installation can defeat even the best planning. Given the financial pressures of completing the setup quickly, it can be tempting for a setup crew to take shortcuts that have a negative effect on the moisture balance. Furthermore, homes are usually set up far from supplies or supervision, making installation shortcomings even more likely.

Manufactured housing is unique in that air conditioning (and heat pump) systems are commonly treated as optional add-on appliances—even in areas where air conditioning is added to every home sold. The majority of air conditioners are installed on-site because half of the system's equipment is mounted on the ground outside the home. Thus, holes are cut through the floor cavity during setup to connect the equipment, potentially exposing the floor cavity and the living spaces of the home to humid outside air.

Make sure the site is properly graded to shed water

Inspect the site before the home is delivered. Water draining under a home can destabilize the foundation as well as increase the chance of moisture migrating into the house.

A home site should be properly graded to shed water before a home is delivered. It is difficult to determine the quality of a good grading job by visual inspection, but a bad job is always obvious. If it looks as though rain will drain along the skirting or actually run under a home, it probably will. The ground under a home need not be level as long as runoff water is routed around the home.

Professional landscape designers should be consulted if the property is near a natural drainage area or shows signs of runoff, or if the landscape is complex. Take into account that runoff from the roof or gutters may concentrate rainwater near a home. Adequate drainage should be provided by sloping the ground away from a home at a 5% grade (6 inches at 10 feet from the side wall) to route any runoff around the home from its natural drainage path. Some retailers allow homeowners to grade their sites to save on setup costs. Don't move a home to a site until the grading is complete and satisfies the guidelines above. Septic tanks and other underground services that could alter the landscape also should be completed before a home is installed.

Other on-site preparations to guard against moisture intrusion are:

- Keep the plastic rain guard that covered the home during transport intact as long as possible during setup. Removing the rain guard is typically one of the first tasks a setup crew undertakes, but any installation delay then puts the exposed building at risk of rain damage. If rain gets into the insulation or other building cavities, it should be allowed to dry out before setup continues. Once a home is put together, its interior cavities will not easily dry out; any water trapped during setup raises the potential for mold problems.
- Consider contingencies when gearing up for installation, and outfit the truck with sufficient amounts of the recommended setup materials. Often homes are set up far from material supply houses; having what is needed on hand will lessen the crew's temptation to take shortcuts or use inferior materials.
- Pay attention to the long-term stability of a home with careful construction of support piers and leveling of the home. If piers are not constructed according to proper design criteria, the home may shift after setup, creating openings that allow rainwater or moist air from the crawlspace into the building cavities and living spaces. Some moisture damage may be an early warning that the foundation has shifted and may be impossible to repair until the foundation is stabilized.

Figure 2.5 Site Grading Practices to Avoid

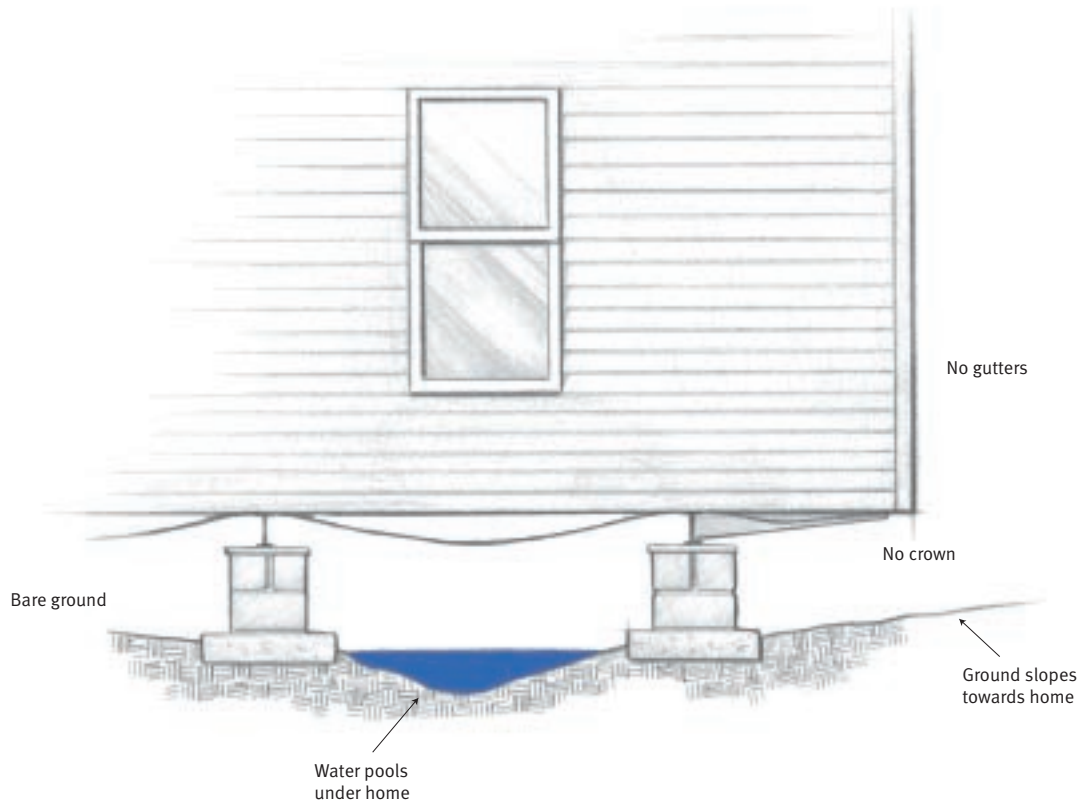

A properly graded site has a crown underneath the home and sloping ground that carries water away from the house, unlike the poor grading job shown above. Gutters and downspouts prevent splash back and direct water away from the foundation. Ground should be covered with a polyethelene sheet.

💧 Seal the marriage line completely

A non-porous gasket should be placed along the inside edge of the insulation in a continuous ring to prevent air and water vapor from infiltrating into the home and wall cavities.

Ensure that the marriage line is sealed with a non-porous gasket and apply an air retarder along the interior wall seams as added protection against air leakage. The gasket should be placed along the inside edge of the insulation in a continuous ring around the marriage line. Using a porous or incomplete gasket will allow air and water vapor from the crawlspace or attic to infiltrate into the wall cavities and interior spaces. Fiberglass insulation and carpet pad are porous and make for a poor gasket. Patching the marriage line with foam after the home is pulled together can leave many sections unreachable and unsealed.

💧 Install a ground cover

Installation of a ground cover is one of the most overlooked and underestimated setup tasks. Water vapor from the ground is often the largest source of moisture load on a house.

A ground cover minimizes the amount of water vapor that accumulates in the crawlspace under a house. Moist air from the crawlspace is often the most significant source of moisture entering a home. The soil, even in a well-graded site, can hold a significant amount of moisture. Cover 100% of the ground with a 6-mil (thick) polyethylene or other vapor retarder, as specified by the manufacturer. It is not necessary to seal joints in the ground cover; overlapping the ground cover material by 12 inches at joints will provide satisfactory performance. It is easiest to install a ground cover before the skirting goes up. Some setup crews prefer to install a polyethylene ground cover before the foundation is set and then cut holes for piers, plumbing, and tie downs.

💧 Ensure that any tears or gaps in the bottom board material are durably sealed

Water vapor from the crawlspace will find its way into the floor cavity through tears in the bottom board, adding to the home moisture load and condensing on cold surfaces, such as uninsulated air conditioning ducts.

Voids in the belly fabric seem to be an inevitable result of transportation and setup. Holes and tears in the belly come from debris on the road or contact with the transport tires; from numerous punctures at the factory (some are intentional, such as the space around the crossover collar that makes room for the flex duct crossover); from lagging the marriage beams together; and from electrical and plumbing crossovers. A complete setup should include repair of all holes in the belly to prevent moist air from entering the floor cavity. The tears must be durably sealed and any lost or shifted insulation must be reinstalled. Holes made through the belly and into the air handler closet to install air conditioning are subjected to the greatest pressure difference in the system. Even a small hole can bring in large quantities of moist crawlspace air. To avoid infiltration, insulate refrigerant lines and seal up holes made for the refrigerant lines and the crossover duct—both at the belly and at the equipment closet floor. Easy-to-use latex and other air-sealing foams are appropriate for this task; tapes are short lived and ineffective.

Repairs to the belly fabric should include both a mechanically fastened cover and a flexible sealant that will resist moisture transport as well as cover the hole. The best bottom board repair technique is to place sheathing material within the belly above the hole, staple the torn belly to the sheathing, apply a sealant—mastic, silicon, or adhesive—to the tear, cover the outside of the tear with scrap belly material or sheathing, and fasten this piece to the sheathing within the belly with staples or screws. Small holes can be repaired with foams designed for air sealing. Most repairs made with tape are not durable, often lasting only a few months.

💧 Leave no metal surfaces exposed when installing the crossover duct

When the air conditioner is operating, metal duct exposed to the crawlspace will become cold and condense moisture from the air. Be sure ducts and metal duct boxes are off the ground, connected securely, sealed tight, and completely insulated.

When installing the crossover duct, it is important to repair any tears in the outer lining and to cover exposed metal surfaces from boots and connections with a minimum of R-4 insulation and a vapor retarder that is approved for outdoor use. Cold metal ducts will condense moisture, which often then drains into the crossover duct insulation layer, reducing the insulating capacity and adding enough weight to the duct to rip through supports. Insulating all the metal surfaces in the crossover connections can be a time-consuming task. Air handlers that are not located over the trunk duct will have a more complex crossover and may have significantly more metal surfaces that require insulation.

💧 Make sure the dryer exhaust duct is supported and installed correctly

Like a drainpipe, the dryer exhaust duct needs to slope downhill and have proper support. Water can easily condense inside this duct, blocking airflow, tearing the duct, and allowing delivery of moist dryer exhaust under the home.

Make sure the dryer exhaust duct is supported so that it slopes downhill. This duct must extend to the outside of the skirting when the crawlspace is enclosed. The exhaust duct must not sag or it will be a site for water accumulation; it should be secured with tape and screws to a rigid exhaust collar that terminates outside of the skirting. In cold climates, the dryer hose should be insulated. Without insulation, when the crawlspace gets cold, moisture will condense inside the hose and can build up until it completely blocks airflow through the hose or until its weight pulls the hose off the skirting or the back of the dryer. In either case, the result is moist air flowing into the crawlspace. A blocked dryer exhaust vent is also a fire hazard.

💧 Properly size cooling equipment and, in humid climates, recommend equipment with higher latent removal capacity

Cooling equipment should be sized to closely match the design load. If the equipment is already installed and has a large overcapacity for the load, set the blower speed as low as 350 cubic feet per minute (cfm) per ton of cooling capacity to increase dehumidification.

Use cooling equipment with a higher humidity removal capacity in humid climates (a latent heat ratio of 25% or higher is desirable). If the air conditioning equipment specified by the retailer is obviously oversized, check with the retailer to see if a smaller capacity can be arranged.⁴ Oversized air conditioning equipment will not sufficiently dehumidify a home and will aggravate several types of moisture problems. Many homeowners and retailers are ill-advised and select larger equipment in the desire to ensure comfort. The air handler blower can be set as low as 350 cubic feet per minute (cfm) per ton of cooling to increase dehumidification. While lowering the flow rate across the coil will increase dehumidification, it should not be considered the cure for an oversized unit. Lowering the fan speed may cause condensation at the registers, can make proper charging difficult, and may cause the inside coil to ice up.

💧 Make sure the air conditioner condensate line is properly trapped and terminates outside of the skirting

An improperly trapped line will not function: air will be drawn in through the condensate line and prevent drainage; condensate water will overflow, often resulting in damage to the floor under the air handler.

Make sure the air conditioner condensate line is properly trapped. Lack of proper condensate drainage could result in spills into the air handler that will damage the floor of the equipment closet or dump water into the ducts or the crawlspace. Some air conditioning equipment is trapped internally and will not work properly if a second trap is inadvertently installed. It is also important to install the condensate line so that it slopes downhill, is supported against sagging, and terminates outside of the skirting.

AVOIDING PROBLEMS THROUGH OPERATION

A homeowner can take many actions that affect the level of moisture in a home. Steps taken during purchasing, setup, and in the day-to-day operation of a home can minimize the risk of moisture problems. Homeowners are typically the first to experience any symptoms of moisture problems. It is up to them to recognize problem symptoms and report them quickly—before they grow into big problems. If residents have allergies or asthma, it is especially important to consider measures for good moisture control.

💧 Eliminate moisture problems at the source

Many moisture problems begin with excess amounts of water deposited into the air by common household activities, such as cooking and bathing. Ventilation fans should be turned on during such activities. They should be left on for a short time after the moisture-producing activity ceases.

Minimize the in-home production and storage of moisture: cover pots while cooking, empty bath tubs after use, cover fish tanks, and don't store large amounts of wet firewood or laundry (they transfer water vapor into the air as they dry). Be aware of the fact that a large number of indoor plants (15 or more) can introduce excess water vapor into a home.

Proper use of whole-house and spot ventilation systems is also an important part of humidity control. Use the whole-house ventilation system for fresh air as needed; operate spot ventilation fans during and for several minutes after cooking or showering. Many people can tell if inside air is humid; however, wall-mounted relative humidity gauges are available at hardware and electronic stores and make it possible to accurately measure the humidity level. Strive to keep the home at 30-60% relative humidity. Use of whole-house ventilation fans in the wintertime or in a home with many moisture sources generally reduces inside humidity levels. Whole-house ventilation in humid climates can add humidity to a home and should not be used excessively.

If, despite these precautions, a home still has a high number of moisture sources, dehumidification equipment may be needed to remove the excess water vapor from the air.

⁴ The Manufactured Housing Research Alliance (MHRA) has published state-specific guidelines for properly sizing cooling equipment called *Manufactured Home Cooling Equipment Sizing Charts*. Copies are available from MHRA.

💧 When it comes to the size of an air conditioner or heat pump, bigger is not better
Air conditioners and heat pumps should be sized to meet the cooling needs of a home. Equipment that is too large will turn off frequently, allowing humidity to build up indoors.

Several precautions can be taken when purchasing and installing a home. One of the most important is to purchase a properly sized air conditioner. Bigger is not better when it comes to air conditioning comfort. Oversized air conditioners are sometimes specified to mask other problems in a home, such as leaky ducts. A larger-than-necessary air conditioner will cool the air quickly but will do a poor job of dehumidification, leaving the air cool but uncomfortably clammy, and the humidity level potentially high enough to promote mold growth. If the thermostat is lowered to offset the uncomfortable clamminess, surfaces in the home become colder, which increases the potential for condensation.

Other actions to take to prevent moisture problems when buying a home:

- Attention to detail during setup can minimize future problems. It is helpful to understand the setup crew's tasks and how they will assure a quality installation. Make sure the home site is properly graded to shed water before the home arrives.
- Insist on a ground cover. Even a well-graded site can harbor a large amount of moisture in the soil under a home. The ground cover is easiest to install before the skirting goes up.
- Tears in the belly fabric are not uncommon during transportation and setup. Make sure that any tears (including those into the air handler closet) are sealed and that insulation is reinstalled if necessary.

💧 Do not use unvented propane, kerosene, or other unvented combustion heaters
About a gallon of water is released into the air for every gallon of fuel consumed. This is a significant source of water vapor that can quickly cause damage. Some unvented heaters can also increase pollutant levels and contribute to health problems.

Many manufacturers specify that use of an unvented combustion heater will invalidate a home warranty. Manufactured homes are more airtight than site-built homes and will not dissipate water vapor added by unvented combustion heaters through infiltration. The ventilation systems built into every manufactured home are not designed to remove the amount of moisture generated from this source. Use an electric heater to spot heat for comfort reasons, and install a vented combustion heater (such as vented fireplace gas logs) if auxiliary heat is desired for power outages.

💧 Do not cover or close off the floor registers
In many homes, air from the heater or air conditioner is distributed through registers in the floor. Covering these registers with furniture or rugs can imbalance the system and create cold spots on room surfaces, increasing the potential for moisture condensation.

Be sure that furniture, rugs, and drapes do not cover the supply air vents. Outside walls depend on good circulation from the supply registers to keep them uniformly warm in the winter. Without good circulation, cold spots that can support mold growth will develop on walls. Closing off individual rooms will also have this effect. Blocked supplies also lower the overall airflow, which can cause overheating and shorten the life of cooling equipment. Stacking items against outside walls in closets also creates cold spots in winter by limiting air circulation, and makes these areas prone to mold and mildew.

💧 Check the cooling equipment filter monthly
Clogged filters can interfere with an air conditioner's ability to remove moisture from the air, and in some cases interfere with condensate drainage. Dirty filters should be either cleaned or replaced. Consider using pleated filters for better dust control and better dehumidification.

Keep the air conditioner functioning to capacity by following maintenance instructions and changing the air handler filter as recommended. The filter cleans the air that circulates through a home and over time will become caked with dust and dirt. A dirty filter can prevent the condensate from draining and cause it to spill out into the ducts or onto the floor, potentially causing structural damage. This task is more difficult in homes where the filter is located behind closed panels.

Keep the thermostat set above 75°F in hot, humid climates

Keep the thermostat setting at or above 75°F in the summer. In high humidity climates, a lower setting could cause water to condense inside wall cavities.

In hot, humid climates, don't set the air conditioner thermostat lower than 75°F. The dew point of the outdoor air can be very high in hot, humid weather. If the indoor temperature is too cold, water vapor will condense within wall cavities. One sign this is occurring is water condensing on outside window surfaces; if it is condensing there, it is also likely condensing inside wall cavities. Use other measures instead to stay comfortable at higher temperatures: use fans to increase air movement; reduce moisture sources in the home; repair voids in the ground cover and tears in the belly material; or install a supplemental dehumidifier.

If a home is still not comfortable except at very low temperatures, consider that the air conditioning system may be significantly oversized. An HVAC dealer may be able to increase a unit's dehumidification ability by lowering the fan speed; or consider replacing it with a unit with better dehumidification potential.

Recognize signs of moisture problems

Big moisture problems started as small ones, and any moisture problem is more easily cured if discovered early on. The following are warning signs of possible moisture problems: persistent musty smells; discoloration on walls or ceilings; swelling of floor, wall, or ceiling finishes; condensation on window glass; or standing water under the home.

Note any odors, especially mold and musty smells. Find the source of the odor and eliminate the cause. Irresolvable odors can be the only clue that wall or floor cavities are rotting on the inside due to an undiscovered moisture problem.

Treat wall and ceiling stains as serious moisture problems. Don't assume these stains are due to rain; often the cause is condensation inside these cavities. If the stains show up during cold winter conditions, it may be due to water vapor moving from the living space and condensing inside the walls on the cold insulation. Stains that show up in the hot, humid summer may be due to water vapor moving from the outside and condensing on the cold cavity side of the wall board. Obviously, if stains occur only after rain, leakage should be suspected. Have the problem fixed before it causes serious damage. In hot, humid climates, painting over stains using low-permeability paints (stain-blocking paints are of this type) can make condensation problems worse.

In many climates, during cold winter months, water occasionally condenses on window panes inside a home. If this happens a lot it signals either excessive humidity in the home or failure of or lack of suitable storm windows. Check that storm windows are properly closed. In the summer, particularly in more humid climates, water forming on the outside of windows is a sign that it is likely condensing within the walls cavities as well. This can happen if the indoor thermostat setting is too low.

Make sure the air conditioner condensate line and dryer exhaust duct terminate outside of the skirting. If no water or water vapor can be detected from these sources, they are probably disconnected and dumping their contents under the home; they need repair.

Correct small problems before they get big. Immediately repair holes made by tree limbs or other damage to roofing and exterior walls to avoid rain leaking into these cavities. Water entering these holes can travel considerable distances (often into the floor cavity, to settle on the belly material) before leaving any symptoms of a problem.

Invest in a thorough home check-up six months after setup to verify that the crawlspace is dry and moisture control strategies are still in place. Have an installation technician crawl under the entire home and inspect the dryer vent, the air conditioner condensate line, low spots in the belly (potentially holding water), and any signs of rain or other water drainage under the home. It is also wise to inspect post-setup installations such as phone and cable lines, and to look for landscape alterations that may direct water under the home.

MOISTURE PROBLEM MITIGATION

This chapter presents a number of typical moisture problems associated with manufactured housing. It is organized by the location of the symptoms, beginning with floor systems because they are the most commonly damaged structural component. It also addresses moisture problems associated with a home's heating, cooling, and ventilation systems. Examples of common problems and their remedies (drawn from actual case studies) are given throughout the chapter.

FLOOR SYSTEM

The floor system consists of the finish flooring (carpet, etc.), subflooring, floor framing, insulation, bottom board material, and metal frame. Since water flows downhill, it is no surprise that floor systems experience more moisture and water damage problems than other building components. Water intruding from outside sources (such as rain through a leaky roof system, or flood water) as well as inside sources (such as plumbing malfunctions and water spills) finds its way into carpets, flooring, and the floor insulation cavity. In addition, water vapor from a variety of crawlspace sources often attacks floor systems from below.

Wall-to-wall carpet is the floor covering of choice in manufactured homes. A carpet and the pad beneath it can readily absorb and hold excess moisture. Carpets also collect dirt, dander, food crumbs, and a host of other nutrients that support the growth of microorganisms. A nutrient-rich carpet with a high level of moisture makes an ideal environment for mold and dust mite populations. Small amounts of these growths are found in almost all carpets, and individuals with extreme allergies to mildew, mold, and other organisms are increasingly excluding carpet from their homes.

To avoid problems associated with microbiological growths, carpets must be kept clean and dry. Keeping a carpet clean means vacuuming it regularly and following up with periodic steam cleaning. Professional carpet restoration is usually required to treat and dry out heavily wetted installed carpet (e.g., from an overflowing sink or flooding). Water damage specialists recommend removal and replacement of carpets that have been wet for several days or more. Substantial mold colonies can form within 48 to 72 hours, and removal of large spore colonies from a carpet and padding is very difficult.

A less obvious moisture problem can occur at the perimeter of carpeting along outside walls. During winter months, the floor adjoining the perimeter of a building is often colder than the rest of the home, and so is its floor covering. This is due to its proximity to the exterior, to insulation compression in the floor, to thermal bridging associated with the framing, and/or to air leaking in under the wall. The resulting cold spot can run the length of a wall. If a cold perimeter area is not well ventilated (e.g., if furniture or drapes block air movement), the cold spot causes a localized increase in humidity or, if cold enough, causes condensation, either of which can support mold growth. It is sometimes possible to inspect these perimeter areas by prying carpet edges from the nail strips and examining the carpet backing, the pad, and the subfloor. The telltale signs of high moisture are rusty nail strips, visible molds, localized odors, and/or cold or damp carpeting.

Moisture Problem Case Study: FLOOR PERIMETER STAIN

Season:	Winter
Symptom:	Dark shadowy line on carpet at room perimeter, particularly under windows. Stain removed by steam cleaning but returned quickly.
Cause:	Noticeable air leakage through the joint between the exterior wall and flooring combined with convection from cold window caused a cold spot on the floor. Window drapes extend to the top of the carpet, preventing air circulation and thus keeping the spot cold. The cold spot increases relative humidity in that part of the carpet and supports mold growth.
Remedy:	Increase ventilation by shortening drapes so they no longer reach the carpet. Caulk where the wall board meets the subfloor, particularly under windows.

Figure 3.1 Floor Perimeter Stain

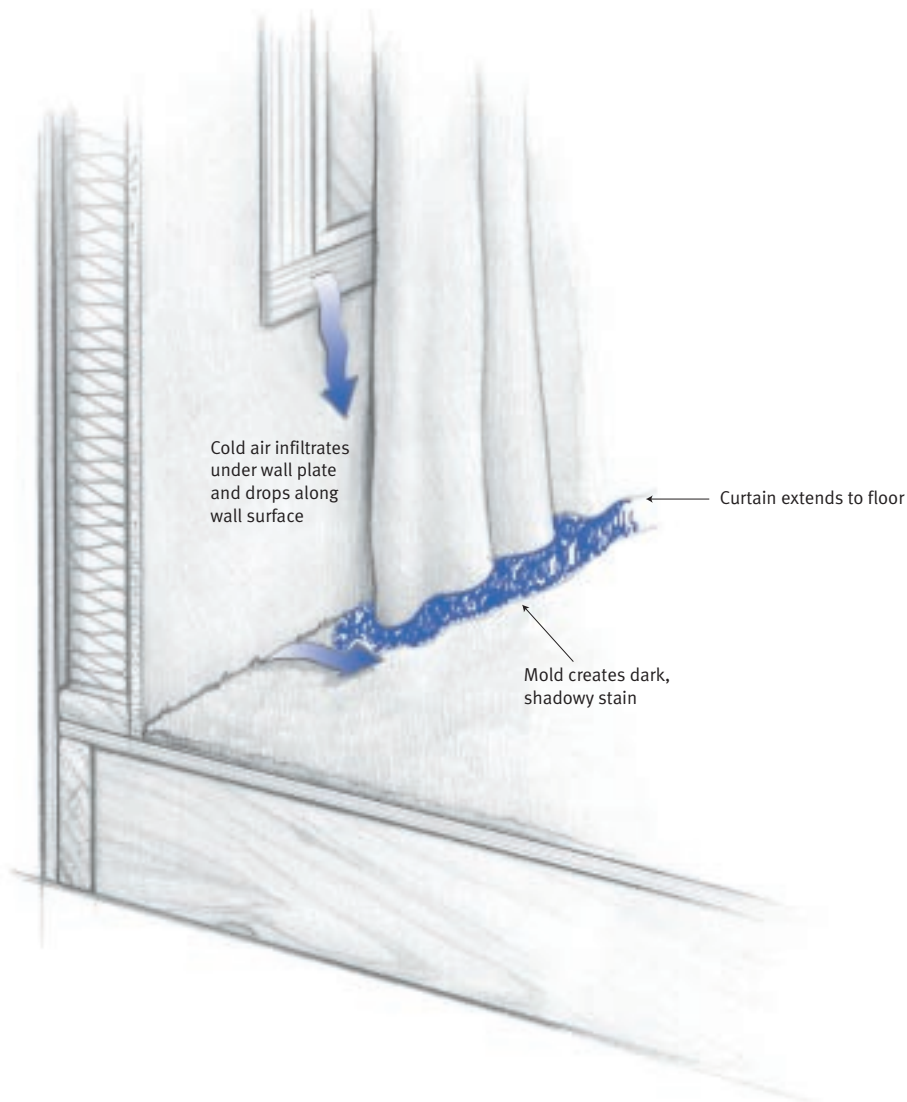

A cold spot at the floor perimeter promotes moisture problems, such as mold growth.

Leaky plumbing accounts for a high number of reported flooring problems. When organic building structural materials like wood are wetted repeatedly, they can absorb water, swell, and eventually lose their structural integrity. In extreme cases, water-damaged floor materials give way under the weight of appliances, furniture, or people—anything that tests its strength. Repairing a subfloor that experiences moisture-related damage is a two-step process involving complete replacement of any soft spots, and removal of the moisture source. During the repair, the belly cavity must be inspected and dried as needed before the subfloor is replaced.

Good home maintenance helps prevent most sources of water damage. Plumbing leaks should be repaired quickly, and major water spills must be thoroughly dried. In both cases, inspection of the belly material is advised to determine if water has accumulated inside the cavity. If water has been trapped, the belly cavity must be opened up, drained, dried, and resealed with a durable repair.

Moisture Problem Case Study: BUMP IN THE FLOOR

- Season:** Summer
- Symptom:** Section of floor expanding, creating noticeable hump.
- Cause:** Large opening in the belly due to improperly repaired holes in the bottom board. Metal duct cooled by air conditioning is exposed to humid crawlspace air, resulting in water condensation on exposed surfaces of the ducts. The adjacent floor sheathing absorbs the moisture condensing on the branch duct. Swelling of the floor sheathing causes the floor to warp.
- Remedy:** Dry out wetted materials. Reinsulate exposed metal duct and floor. Staple new belly material over the hole and seal with silicon. Install ground vapor retarder to reduce moisture that evaporates from the ground. Adding weight to the hump may help bring it back to level as it dries. If not, cut out and replace the affected flooring.

Figure 3.2 Bump in the Floor

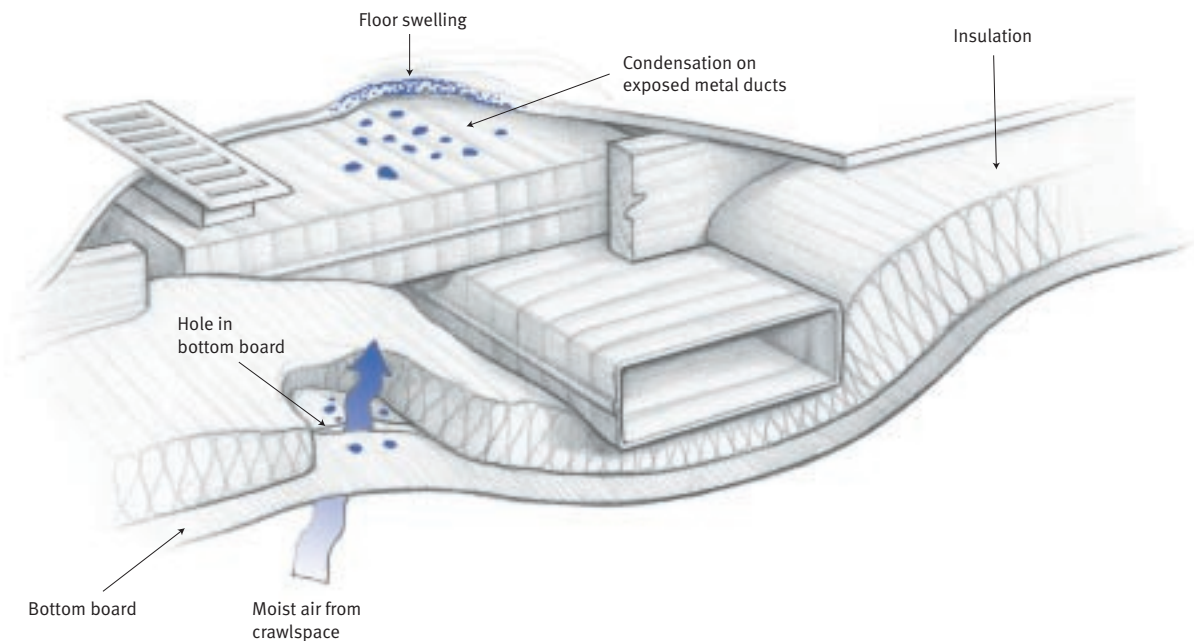

Warping of the floor sheathing can occur when a hole in the bottom board allows moist crawlspace air to condense on exposed metal ducts. Water is absorbed by the floor sheathing, which swells.

Fiberglass insulation is the most common material used to insulate floor systems in manufactured homes. This insulation is highly porous and can hold a significant amount of moisture. Moisture in the floor system can condense in the insulation, potentially leading to mold and mildew problems and dramatically reducing its insulating properties. Damp insulation can be dried out and reused; deeply wetted (soggy) insulation usually must be removed and replaced.

If the floor system gets wet, the bottom board—typically a polyethylene membrane that wraps the floor system—prevents water from draining away from the structural materials and slows the drying process. In the case of a significant plumbing leak, water spill, or condensation in the floor frame, it is not uncommon to find water pooling on top of the bottom board within the floor cavity.

Moisture Problem Case Study: **BULGE IN THE BELLY**

Season: Summer and winter

Symptom: Section of belly material bulging considerably, and the bulge is heavy and cold.

Cause: Any source of water leaking into the floor cavity—in this case, a poorly sealed bathtub—can allow gallons of water to pool on the bottom board. Left unchecked, the tub leakage could rot out a large section of floor materials.

Remedy: Reseal the tub. Strengthen any weakened floor joists. Replace belly insulation and restore the belly material.

Figure 3.3 Bulge in the Belly

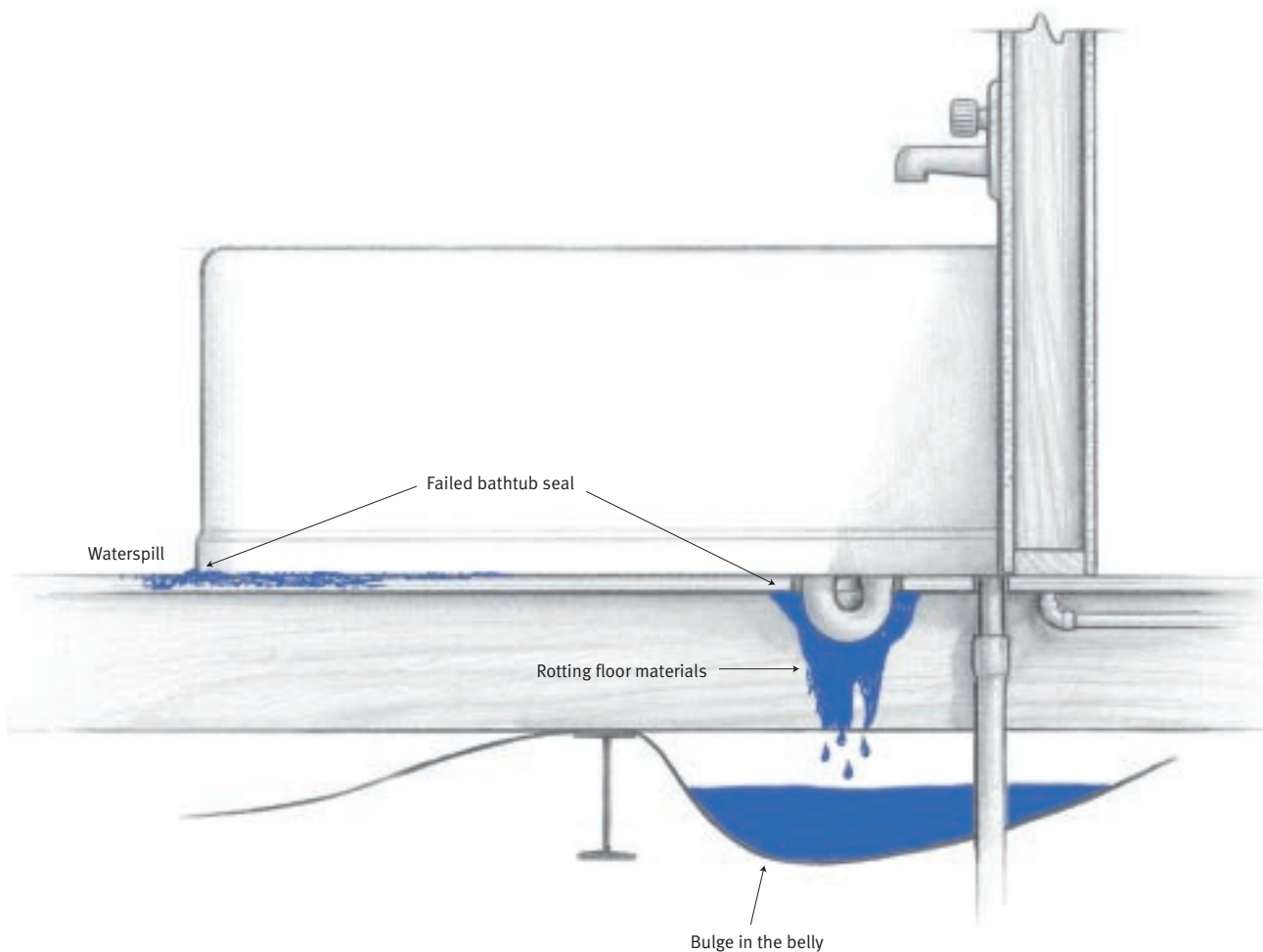

When seals around tubs fail, water drains into the floor cavity and pools on the bottom board. Unchecked, the leaks can rot out floor materials.

WALL AND WINDOW SYSTEM

Because they have less depth for insulating material, wall systems generally offer less thermal resistance (R-value) than do thicker floors and ceilings. Windows offer even less resistance to the flow of heat. The lower thermal resistance of glass results in interior glass surface temperatures that can approach outdoor temperatures. Temperatures at the window surface and at cold spots on a wall can easily fall below the dew point of the indoor air and cause condensation. A window is generally the coldest surface in winter and thus is the surface where water vapor inside the home first condenses. During extreme cold spells, windows in many homes become cold enough to condense and even freeze water on the inside surface. If this happens only occasionally and is mopped up, such condensation rarely causes damage. Wall systems are also particularly susceptible to wind-driven rain leakage at window and door flashings and at improperly sealed penetrations.

HUD's Manufactured Home Construction and Safety Standards⁵ (MHCSS) offers choices for the control of condensation. One alternative is the use of a vapor retarder. A second is an external covering or sheathing that forms a pressure envelope limiting air and moisture leakage. Vapor retarders are coatings that slow the rate of molecular diffusion of water through building materials. These include special paints or a vinyl coating adhered to gypsum wall board. Coatings with a rating of less than 1 "perm" are considered effective vapor diffusion retarders.

The HUD-code sets the location for the vapor retarder at the inside surface (the living-space side) of the home. This strategy minimizes the amount of water vapor that diffuses into the wall assembly from inside the home. Although suitable for protecting wall cavities in the northern climates from wintertime condensation problems, recent experience shows this strategy may be problematic for air-conditioned homes located in hot, humid climates. In these homes, the moisture level is higher outside than inside, reversing the direction of water vapor movement such that it flows from the hot, humid outside environment through the wall components and into to the cooler and dehumidified home interior. The interior vapor retarder acts like a dam holding water inside the wall board. When the conditions support condensation inside the wall, water will begin to condense on the coldest material—in this case, the inner surface of the wallboard. If the conditions for drying are poor—the outside humidity is high and the vapor retarder blocks diffusion to the inside—moisture will begin to accumulate on the surface and saturate the material. If the wall board cannot dry out, it will eventually fail completely. Wetting of the gypsum usually occurs at night and walls partially dry out during the day as they heat up. Adding insulation to these walls may make the problem worse by slowing the daytime drying. In a humid climate, similar problems can occur with any wall whose interior is open to the outside air—including poorly sealed marriage lines. (At this writing, HUD is considering a waiver allowing manufacturers to move the vapor retarder to the outside surface of the wall in the hot, humid climates of the Southeast.)

Water condensing on a windowpane inside a home is another common concern. This happens when the window's thermal resistance properties are too low for the climate (such as when the storm window is left open during a cold period) or when the humidity level of the home is elevated. Often it is a combination of the two factors.

During the heating season, it is not uncommon to find homes heated by unvented propane or kerosene heaters, despite the fact that nearly every home manufacturer explicitly warns against the practice. Unvented heaters add about a gallon of water to the air for every gallon of fuel they consume. A kerosene heater that burns two gallons of fuel per day can raise the relative humidity from 55% to 70%, sufficient to upset the moisture balance in the home and cause condensation on building surfaces.

⁵ PART 3280, Manufactured Home Construction and Safety Standards and Interpretive Bulletins to the Standards, US Department of Housing and Urban Development (HUD), April 1999

Moisture Problem Case Study: INTERIOR WALL FILLED WITH OUTSIDE AIR

- Season:** Summer (mostly in the humid Southeast)
- Symptom:** Interior walls swelling and bowing—by as much as 3 inches in some places. Some of the vinyl-coated gypsum wall board behind the swelling is soft to the touch.
- Cause:** Removal of bowed interior walls revealed poorly sealed holes into the attic space for electrical wiring. Humid outside air was being driven into the wall by the attic ventilation system. The thermostat was set quite low (68°F) such that the cavity side of the wall board was cold enough to condense water vapor from the humid air.
- Remedy:** Remove failing sections of the wall. Seal the electrical cable holes to prevent outside air from entering the wall cavity. Replace the wall board. Encourage the home owner to set the thermostat higher, and suggest measures to increase comfort at that setting.

Figure 3.4 Interior Wall Filled With Outside Air

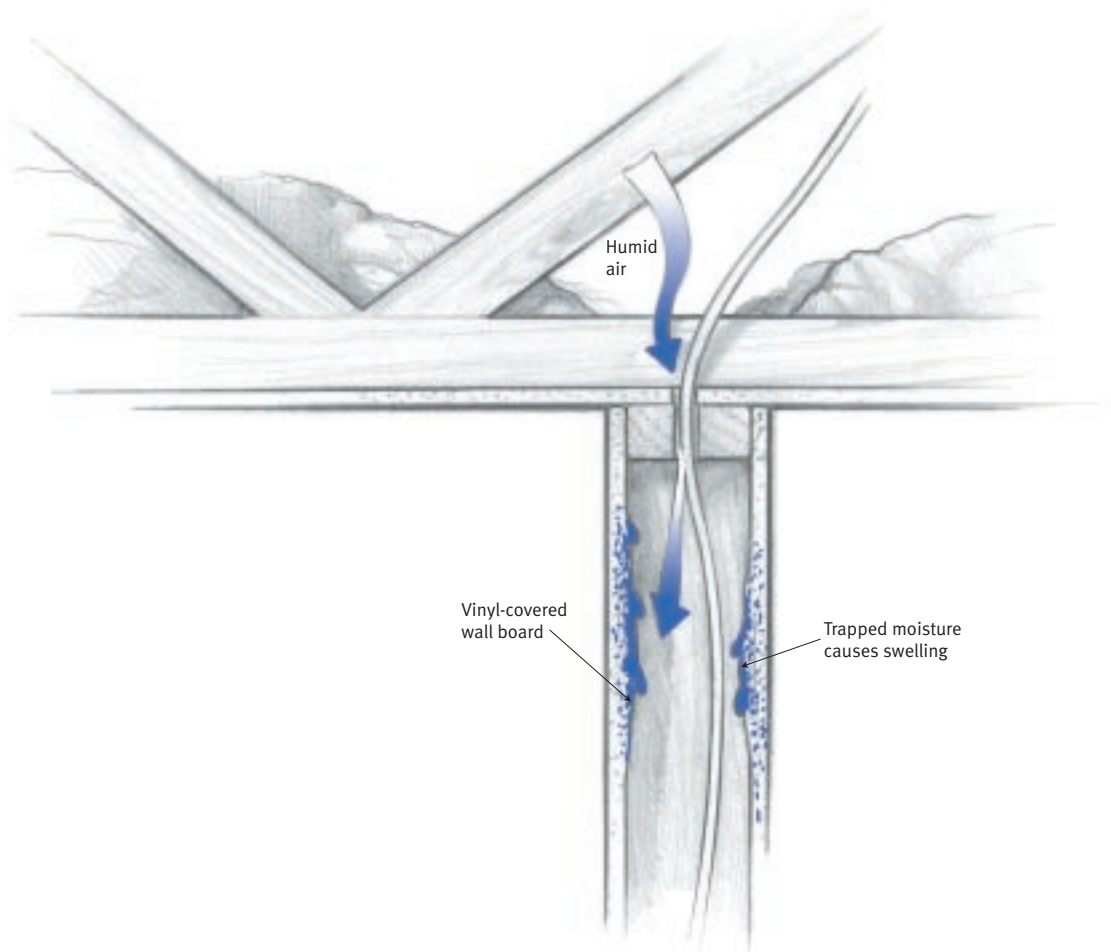

Humid outside air can enter an interior wall cavity through poorly sealed holes for wiring. Moisture condenses on the cold wall. The moisture cannot dry through the vinyl, causing the interior wall to swell.

Moisture Problem Case Study: VAPOR RETARDER ON THE WRONG SIDE

- Season:** Summer (mostly in the Gulf Coast states)
- Symptom:** Indoor surface of the exterior walls "bubbling." Gypsum wall board beginning to disintegrate.
- Cause:** Exterior walls with siding open to the outside allow humid air into the wall cavity where it can condense on cold surfaces. A vinyl-coated finish on the gypsum wall board prevents this moisture from drying to the inside. This home was installed on gravel fill with a marshy area nearby, creating a zone of high humidity around the home. The thermostat was set low, at 70°F, increasing the potential for condensation.
- Remedy:** Removal of the interior vapor retarder may not be feasible. First step: raise the cooling set point to 76°F so the temperature inside the wall is more often above the dew point. Use ceiling fans and a dehumidifier to improve indoor comfort. Second step: remove affected wall panels and seal all openings in the cavity to slow air intrusion from the outside. Replace failed gypsum wall board with plain gypsum covered with vapor-permeable paint, which will allow water vapor to more easily migrate through the wall board.

Figure 3.5 Vapor Retarder on the Wrong Side

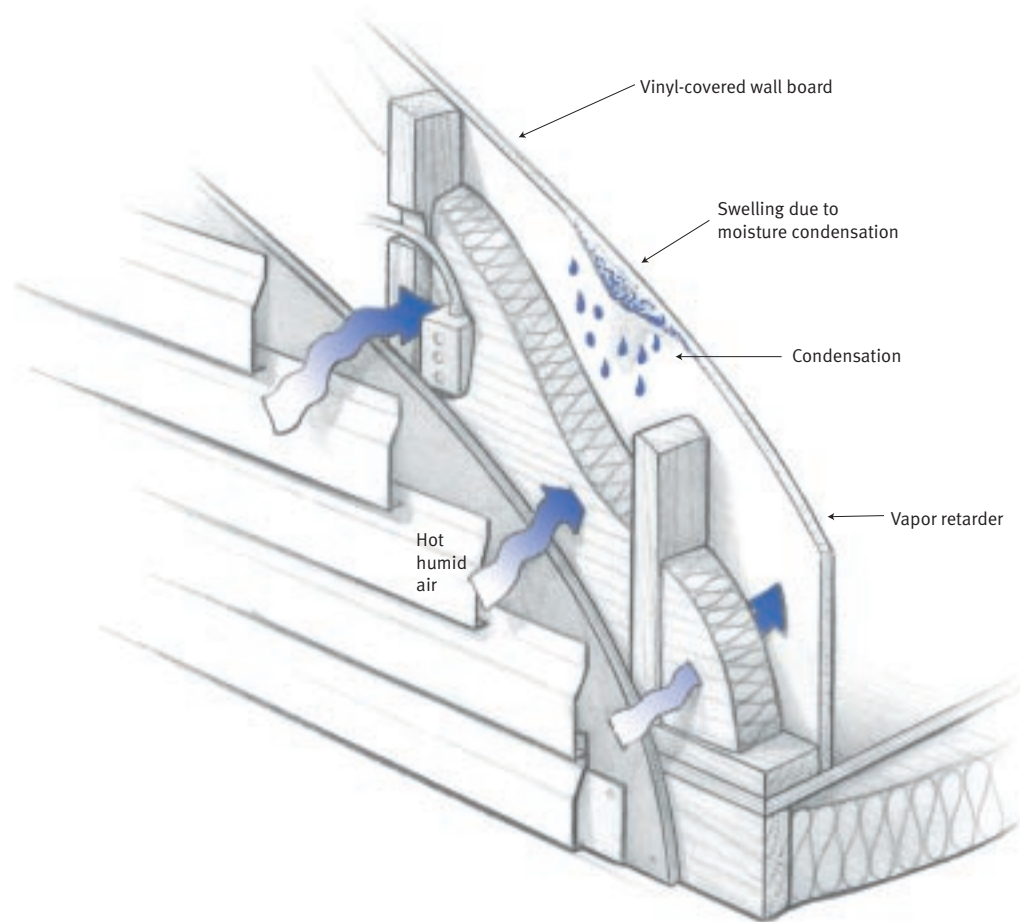

When the vapor retarder is on the interior wall in hot, humid climates, warm, moist air that enters the wall cavity can accumulate on the cold interior wall board, which swells and disintegrates.

Moisture Problem Case Study: MISPLACED WINDOW FLASHING

Season: Summer and winter

Symptom: Wall sections underneath windows are damp and growing mold.

Cause: Flashing installed around the windows is not functioning properly: rainwater is deposited behind the asphalt paper rain screen. This detail was installed incorrectly at the plant.

Remedy: Remove siding and window and correct immediate failure in the field. Educate installers in the plant and recommend closer plant supervision of this detail.

Figure 3.6 Misplaced Window Flashing

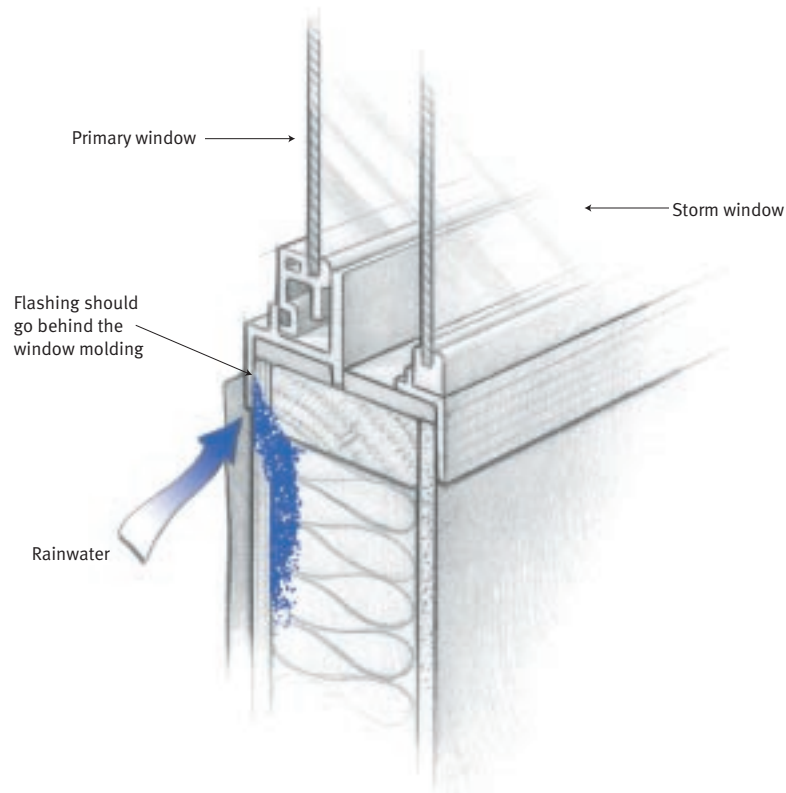

When windows aren't installed properly, rainwater can be driven behind the rain screen.

Moisture Problem Case Study: CONDENSATION BETWEEN GLASS PANES

- Season:** Winter
- Symptom:** Water condensing on the primary window—in between the two panes of glass—in a home with inside storm windows.
- Cause:** The air handler and ventilation system in this home slightly pressurize the home when they operate, pushing air out wherever there are leaks. Leaks in the primary window allow conditioned indoor air to flow behind the storm window onto the relatively cold primary window, where it condenses.
- Remedy:** Achieving a perfect pressure balance in a home is very difficult. It is ideal to have a slightly negative pressure in the home during the winter and positive pressure in summer—thus always forcing the drier air into building cavities. The best solution: seal up leaking storm windows. If air can be felt escaping through a "finger width" crack in the front door when it is open and the air handler is on, then the home may have a significant pressure imbalance that may be forcing moist air into other cavities as well.

Figure 3.7 Condensation Between Glass Panes

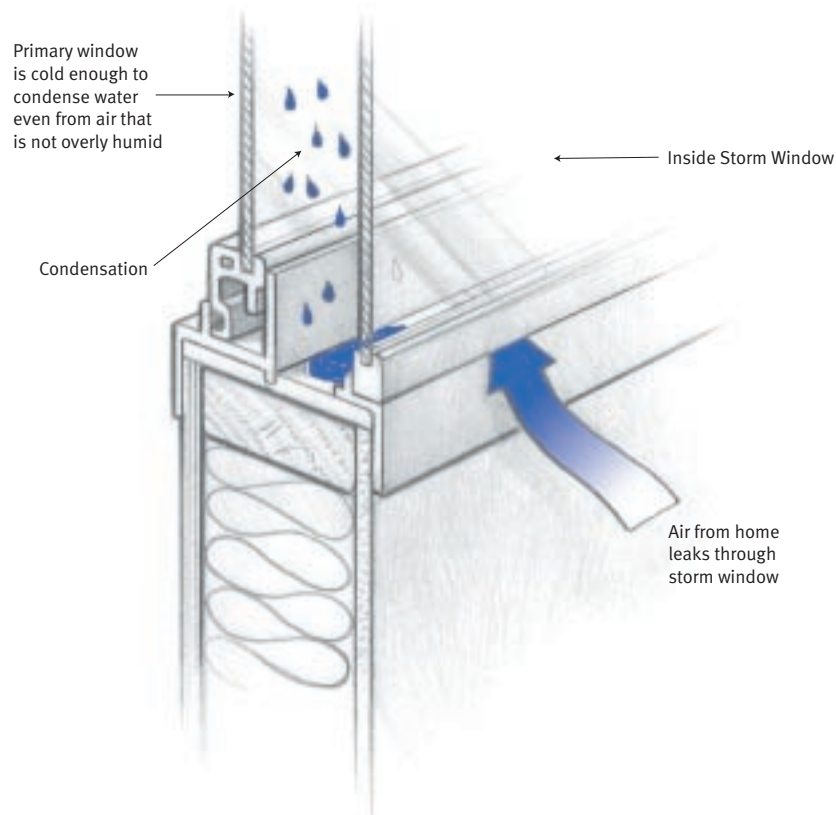

Pressure imbalance in a house will push warm air through leaks in the interior window allowing moisture to condense between the two panes of glass. A durable seal should be applied to the storm window to minimize leaks.

Moisture Problem Case Study: WATER ON WINDOWS

- Season:** Winter
- Symptom:** Water running down inside the window glass onto windowsills, peeling the paint and softening the surrounding material.
- Cause:** Excessive interior humidity—generated, in this case, by an unvented combustion space heater. (Note: The problems caused by unvented heaters are so serious that their use may invalidate a home's warranty.)
- Remedy:** Eliminating the unvented heater cleared up the moisture problem within one week. Significant residual moisture absorbed by the furniture and other materials often will take some time to dry out.

Figure 3.8 Water on Windows

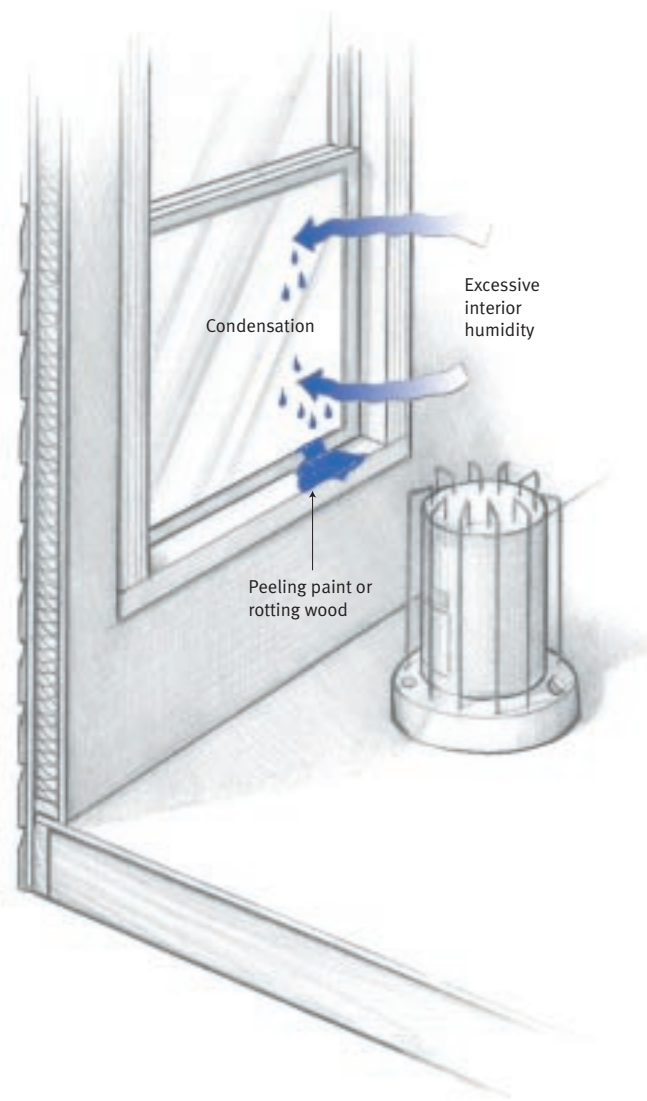

In winter, excessive interior humidity causes water to condense and run down inside the surface of the window glass and damage the sill. Unvented combustion space heaters that give off a good deal of moisture are sometimes the culprit.

Moisture Problem Case Study: FROZEN WALLS

- Season:** Winter (mostly in the extremely cold North)
- Symptom:** Home will not stay warm. Walls are cold to the touch.
- Cause:** Water vapor migrating into the walls has condensed and frozen within the wall insulation. The vapor retarder on the inside has failed and/or water vapor is being driven into the wall cavities by a combination of holes in the wall and positive air pressure in the home.
- Remedy:** The exterior wall finish must be removed and wet and frozen insulation removed and replaced. Penetrations through the interior wall must be sealed and the vapor retarder must be repaired (e.g., by painting the interior with a vapor barrier paint). Diagnose the cause of the pressure imbalance (perhaps excess powered ventilation) and repair.

Figure 3.9 Frozen Walls

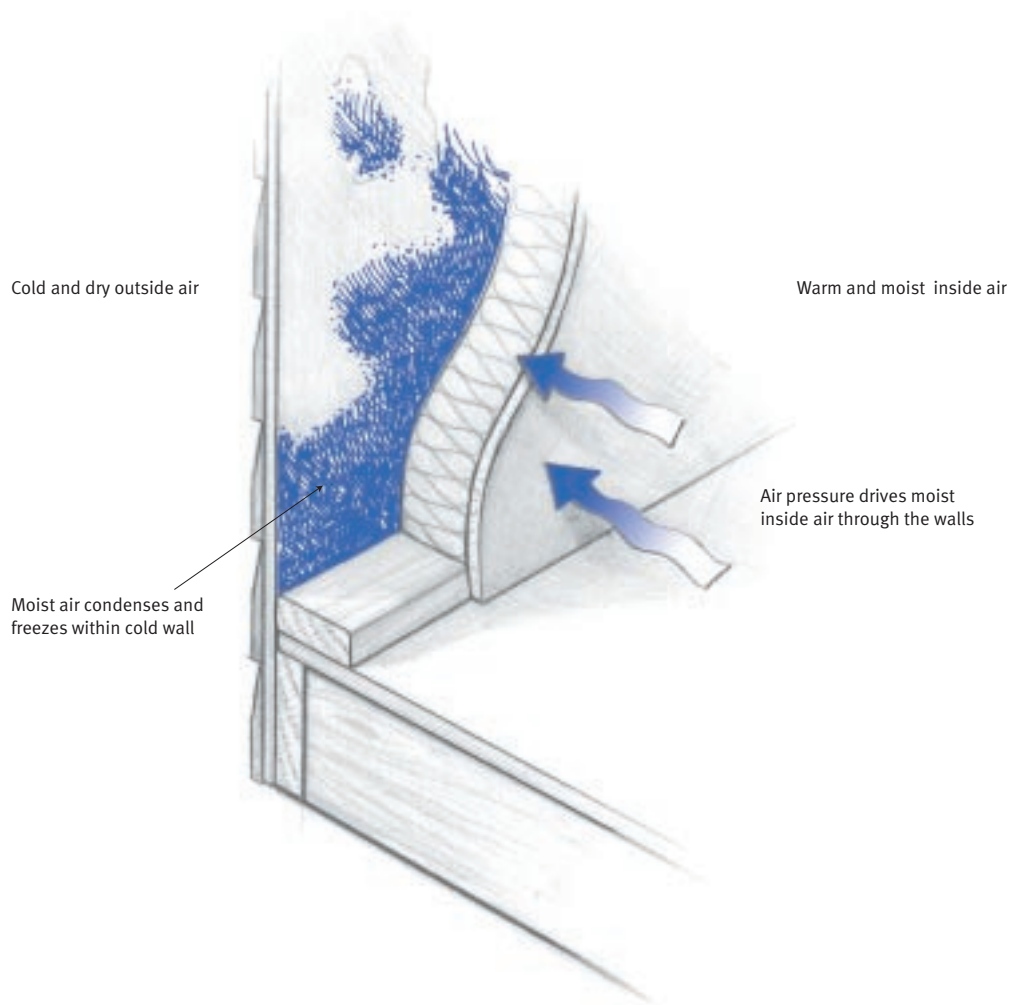

Static and vapor pressure drives moist inside air through the walls, where it condenses on the insulation and freezes. The frozen walls are cold to the touch, and the home will not feel warm.

ROOF SYSTEM

The roof system covers the home and provides the primary weather barrier as well as a main thermal barrier. From the outside, the roof assembly consists of shingles or other finish material typically nailed over a rain screen, sheathing, a roof truss frame that provides an attic cavity, the ceiling insulation layer, and, finally, the interior ceiling board. A roof's most elemental function is to shed rainwater and snow, and typically there are few problems in this regard. The more roof penetrations that exist, such as vents and skylights, the greater the risk of leaks around these penetrations. Obviously, any damage from tree limbs or other debris puncturing a roof should be repaired immediately to minimize the potential for water damage. If a leak has already occurred, the roof system should be allowed to dry before any repair work is completed. With a manufactured house, gaining access to the roof cavity is very difficult and should be attempted only by a qualified repair contractor. Roof moisture problems are not always easy to diagnose; the symptoms of moisture damage are often far removed from the source of moisture.

A common roof system moisture problem arises when moisture diffuses or infiltrates from the living space into the roof system and condenses or freezes within the attic cavity and later drips onto the ceiling material. Many roofs are unnecessarily reshingled because this moisture problem is misdiagnosed as a leaking roof. The HUD standards require that ceilings be designed to control condensation and dictate the use of a ceiling vapor retarder in cold climates. This vapor retarder is optional in warmer climates. These provisions, however, do not necessarily protect the roof system from moisture transported by air moving through holes in the ceiling for lights, speakers, or other electrical devices.

Ice dams are a common phenomenon in climates that get a lot of snow. They occur when either insulation is insufficient or warm home air enters the roof cavity through penetrations in the ceiling. In both cases, the roof sheathing is warmed enough to melt snow resting above it on the shingles. The melted water trickles down to the colder surfaces at the edge of the roof; there it refreezes and forms an ice dam on top of the shingles. Once a dam is in place, additional melt water backs up and seeps through the bottom edge of the shingles and into the roof cavity. Gravity then carries the water down to drip on the ceiling or to flow down the wall surfaces and cavities.

Preventing ice dams in manufactured housing requires adequate and evenly distributed ceiling insulation, and a continuous air retarder throughout the ceiling. These two measures minimize the amount of home heat that can enter the attic cavity. The third measure is to properly ventilate the attic. Ventilating the attic cavity helps dissipate heat in the attic that contributes to ice damming.

Water vapor that gets into an attic cavity through holes in the ceiling board and condenses on the cold attic materials causes other problems. Condensation that forms on the cold roof sheathing in winter can run down the underside of the roof and collect in the soffits. Some of this water may appear as water droplets or icicles on soffit vents. Some of the water can be absorbed by the ceiling material and shows up as stains. To solve wintertime moisture condensation in the attic cavity requires sealing any holes in the ceiling membrane. Once all punctures are sealed, painting over the stains and monitoring the site carefully is wise to double-check that all moisture sources were addressed.

Stains that form on a ceiling during or immediately following a rainstorm are signs of a roof leak. If such stains appear, it is prudent to investigate all penetrations through the roof, especially those uphill from the stain site, and repair the roof as necessary (seal a metal roof only with a paint designed for that purpose). Particular attention should be paid to any area that may have been damaged by tree branches or other debris. If the stains continue or enlarge, an experienced contractor should be consulted to determine if reroofing is appropriate. To prevent mold, water in the attic should be dried out before undertaking repair work, especially in homes with no attic ventilation.

Moisture Problem Case Study: ICE DAM

- Season:** Winter (high snow regions)
- Symptom:** Water dripping out of ceiling lights and along the bottom of the outside wall; puddles of water on the floor in some rooms; visible ice buildup at roof edge.
- Cause:** Warm air from the home is entering the roof cavity through holes in the ceiling at recessed can light fixtures. Attic ventilation is blocked by snow and/or insulation and is thus unable to circulate dry, outside air.
- Remedy:** Decrease the temperature of the attic cavity and roof sheathing: seal the leaks caused by the recessed light fixtures, and clear insulation blocking the soffit vents to increase attic ventilation.

Figure 3.10 Ice Dam

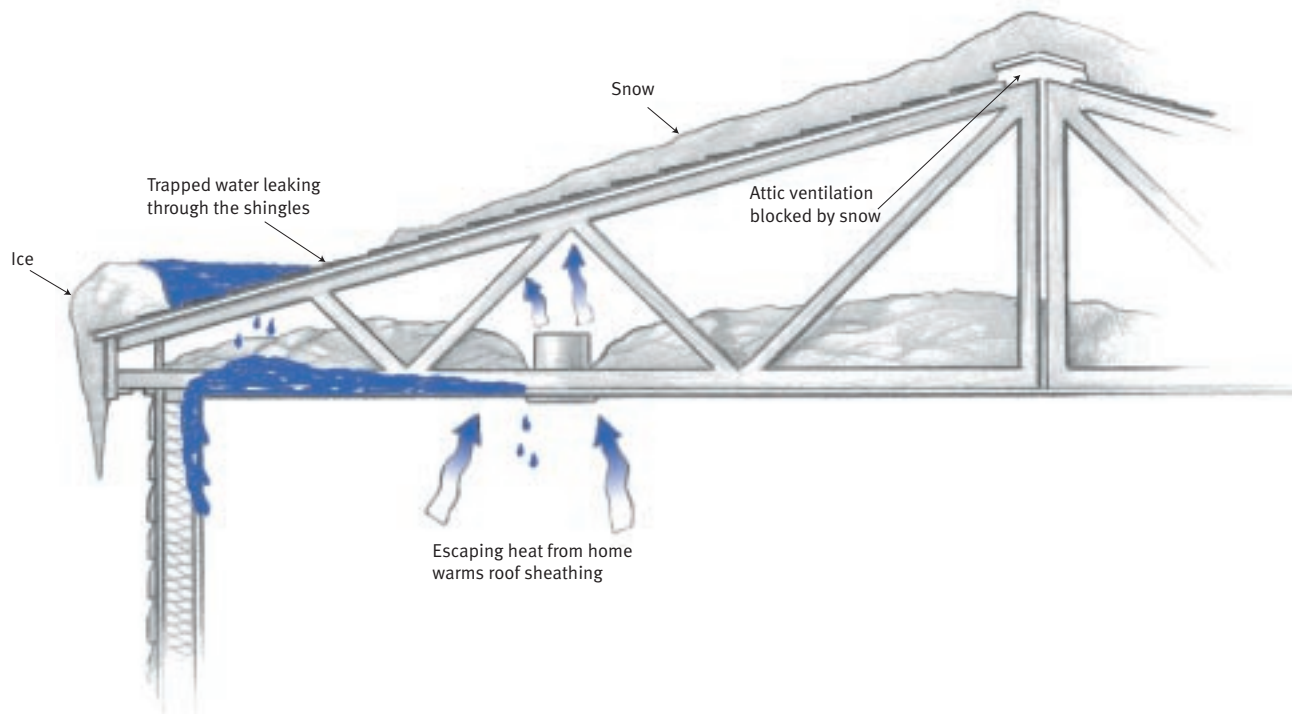

Ice dams occur when attic insulation is insufficient or warm home air enters the attic space. Melting snow or ice on the roof surface backs up and seeps through the shingles into the roof cavity, damaging materials and reducing insulation values.

Moisture Problem Case Study: ATTIC CONDENSATION

Season: Winter

Symptom: Brown water stains appeared on the ceiling just above the outside wall during a dry but cold period. The homeowner coated the metal roof with roof cement and painted over the stains. The stains reappeared during a subsequent cold spell.

Cause: Moist air from the home is leaking into the attic and condensing on the underside of the roof sheathing. From there it runs down the sheathing and is absorbed by the ceiling material.

Remedy: Seal all penetrations through the ceiling. Check to see if bathroom and kitchen fan vents are secure and not venting into the attic cavity. Paint over stains again and monitor sites.

Figure 3.11 Attic Condensation

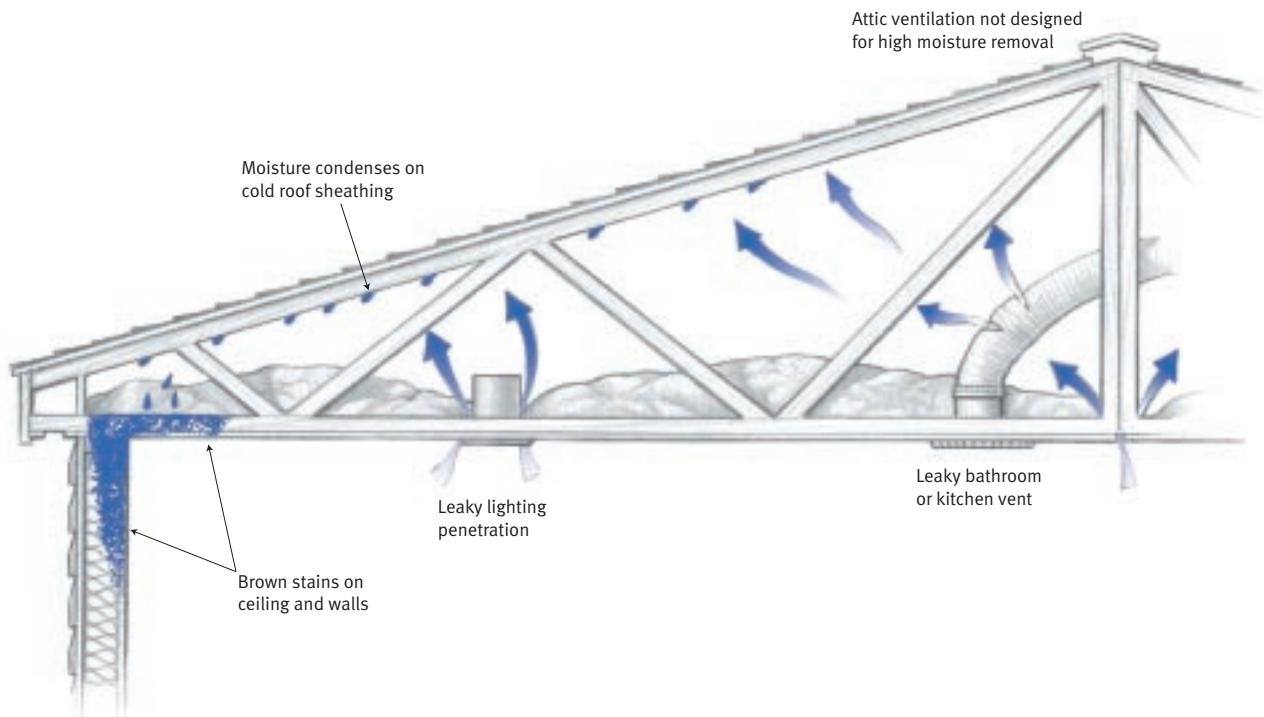

Warm, moist air that leaks from the home into the roof cavity will promote condensation on the underside of cold roof sheathing. Water runs down and is absorbed by the ceiling and wall sheathing, creating stains.

EQUIPMENT CLOSET

Manufactured homes typically come with a heating system installed at the plant. Usually this is a furnace that is located within a special equipment closet inside the home, often along with the water heater. Additional air conditioning equipment is typically installed on-site; the evaporator is installed alongside the air handler and the condenser is located outside of the home. Heated or cooled air is distributed through a duct system that is located in the floor or attic space. In most homes, air returns to the furnace through an intake grille in the door or wall of the equipment closet.

Air conditioning equipment is more often associated with moisture problems than is heating equipment. Air conditioners dehumidify the inside air as well as cool it, and several variations of moisture problems can arise if an air conditioning system cannot properly dispose of the condensate that it removes from the air or if conditioned air cools the surface of building materials.

A common air conditioner problem is a clogged condensate line. In most air conditioning systems, condensate water produced when the air conditioner is running drips into a collecting pan at the bottom of the coil and overflows into a condensate line. The condensate line is a sloped pipe that drains water outside the crawlspace skirting of the home. If this drain line becomes clogged, the water in the drain pan overflows into the furnace and/or onto the floor. Several days of a clogged condensate drain can cause major damage. A wide range of materials can accumulate to block a condensate line, including home dust, animal dander, sediment and rust from the coil, and biological growths.

To drain properly, condensate lines also require a trap, similar to the trap under a sink. Condensate lines without a water-filled trap will suck in air, preventing water from draining while the fan is operating—again setting up conditions for condensate to overflow the collecting pan.

Filters are used to clean the air stream that feeds the heating and cooling equipment. If the filter is not changed frequently enough, it will clog with dirt and restrict the volume of air reaching the heating or cooling elements. "Starved" for air, the fan will begin pulling air from around the edges of the coil and the condensate pan, preventing the water from running out the condensate drain, causing it to spill out. Since an air handler is not watertight, the water often ends up wetting the equipment closet floor. Such problems—particularly in equipment closets with the difficult-to-access screw-on panels—may go unnoticed for long periods of time.

Ideally, an air conditioner condensate line drains water to a point beyond the home skirting. Condensate water drained into the crawlspace can be a significant source of moisture problems. A central cooling system can discharge 10 gallons or more of water through its drain line on a hot, humid day. If the drain discharges water on top of the ground vapor retarder, a large puddle of water can form in the crawlspace and persist throughout the cooling season—fostering a variety of moisture problems (see discussion of crawlspaces on page 3.17).

Moisture Problem Case Study: CLOGGED FILTER

Season:	Summer
Symptom:	Air conditioning equipment not cooling home.
Cause:	As the result of a heavily clogged air filter, the "starved" air handler fan sucked condensate water out of the drain line and the water leaked onto the subfloor. The water softened the particle board subfloor, causing the air handler and top-mounted cooling coil to partially collapse through the equipment room floor. The weight of the system crushed the main supply duct under the air handler.
Remedy:	Remove the air handler and cooling coil. Replace the subfloor, straighten the collapsed duct, and reinstall the air handler and cooling coil. Clean the air handler and install a new filter. Instruct the homeowner on how to check and replace the filter monthly.

Figure 3.12 Clogged Filter

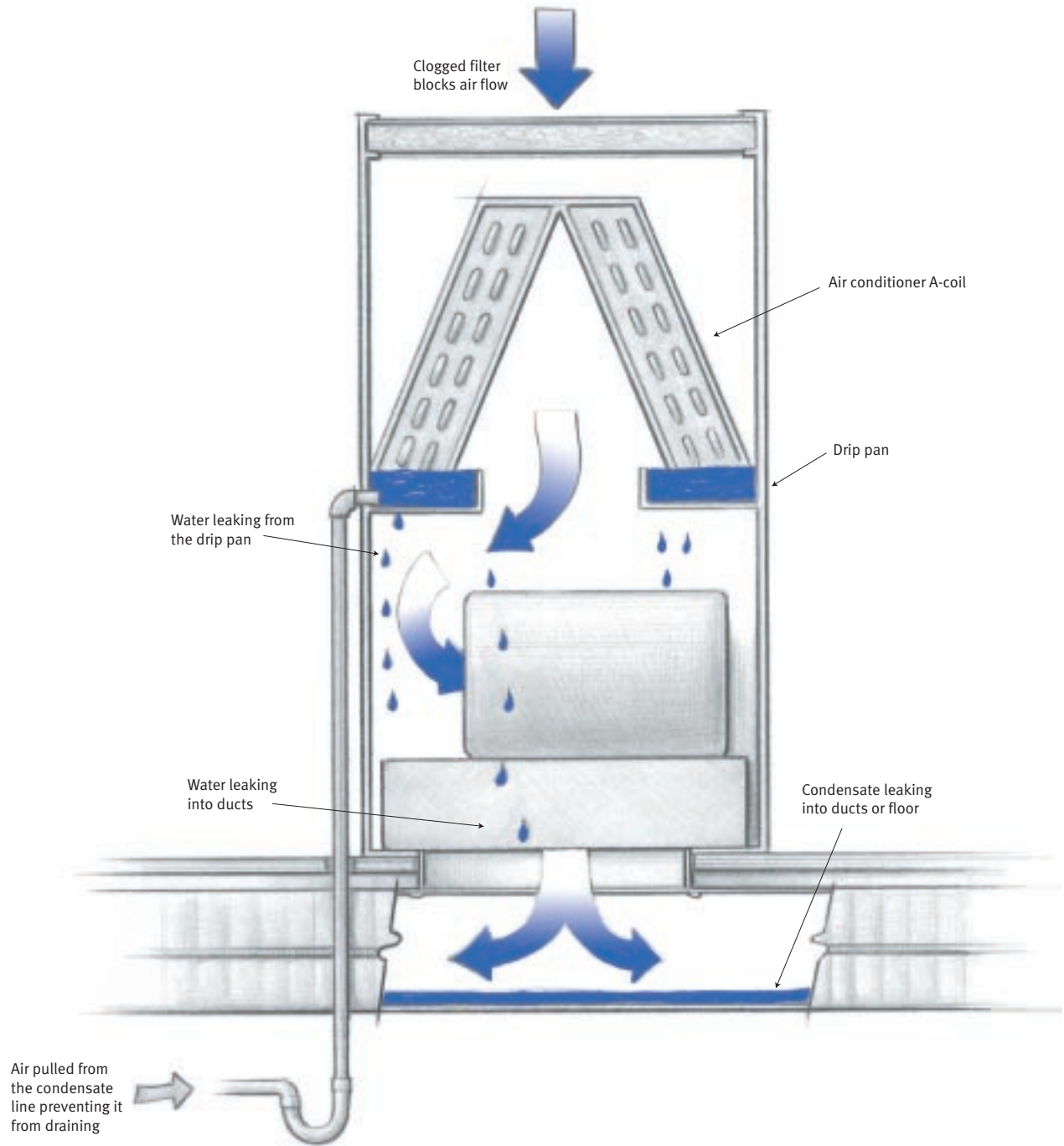

A clogged air conditioner filter blocks return airflow, and the "starved" air handler fan sucks water out of the drain line. Water spills into the air handler cabinet, leaking into ducts and seeping into the floor.

CRAWLSPACE

The crawlspace is the area directly under a home. Ideally the ground in the crawlspace is completely covered with a vapor retarder such as a polyethylene sheet, and the ground slopes away to shed rainwater away from the home. Even with these precautions, the crawlspace is often a major source of moisture. Crawlspace moisture comes from water vapor evaporating from the soil; infiltration of humid outdoor air through vented crawlspace walls, rainwater runoff, and spills and other water leaks.

Figure 3.13 Crawlspace Moisture Control and Ventilation

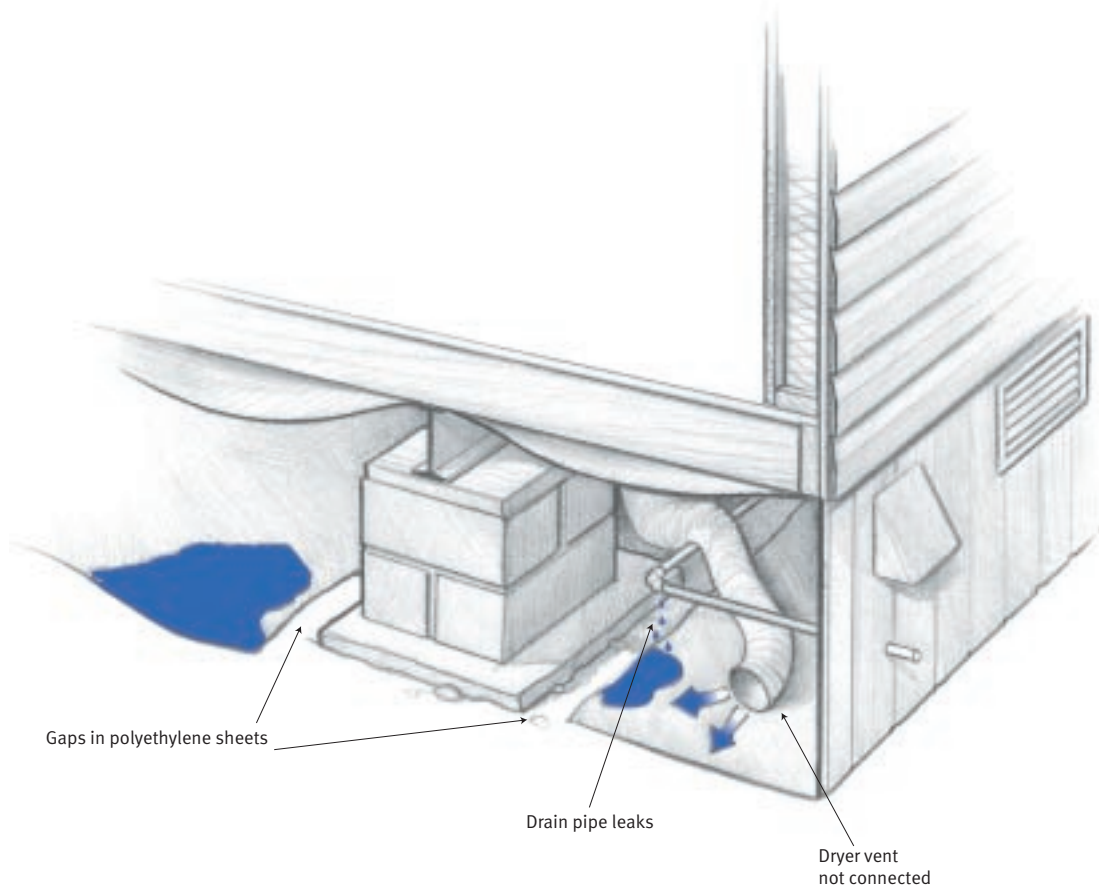

Crawlspaces are a major source of moisture. To keep the crawlspace dry, cover the ground with a continuous polyethylene sheet and install properly sized skirting vents. The dryer should vent and the condensate line should drain to the outside.

Crawlspace walls are typically ventilated to allow water vapor to escape. Observations in more humid climates show that crawlspace ventilation can actually increase moisture levels in the crawlspace where, in the relative coolness, it can condense and form puddles. Regardless, ventilation is typically insufficient to remove significant amounts of water, so moist air from the crawlspace is in good position to gain access to the floor cavity through holes in the bottom board. Once in the floor cavity, the moist air dampens structural materials and diffuses into the conditioned space. Some of this moist air will be blown through penetrations in the floor cavity into the home when the air handler comes on. If penetrations exist between the crawlspace and the walls above, moist air is blown into the wall cavities as well. For all these reasons, it is important to keep the crawlspace dry and sealed from the building interior.

Persistent water in the crawlspace can soften the soil beneath pier supports and other parts of the foundation system. When this happens, the load-bearing capacity of the soil decreases and eventually the weight of a home can force the home to shift. Excess crawlspace humidity also promotes rust on the painted steel chassis. Further, wooden skirt framing and sheathing can absorb crawlspace moisture. Wet wood rots and invites termites and insects to infest the home.

Moisture Problem Case Study: RAINING IN THE CRAWLSPACE

- Season:** Summer (mostly in the humid Southeast)
- Symptom:** Extreme condensation in crawlspace: water dripping from large patches of the belly onto the plastic vapor retarder covering the ground.
- Cause:** Air leaking from the underfloor duct system cools the belly material enough in some areas to support condensation of the moist crawlspace air. A significant duct leak was found directly underneath the air handler.
- Remedy:** Remove the crossover duct underneath the air handler to gain access to the inside of the duct. Apply approved duct mastic to the seams of the duct boot. Bridge gaps larger than one inch with fiberglass mesh tape along with the mastic. Do not use tape. Tape is ineffective for long-term sealing of duct.

Figure 3.14 Raining in the Crawlspace

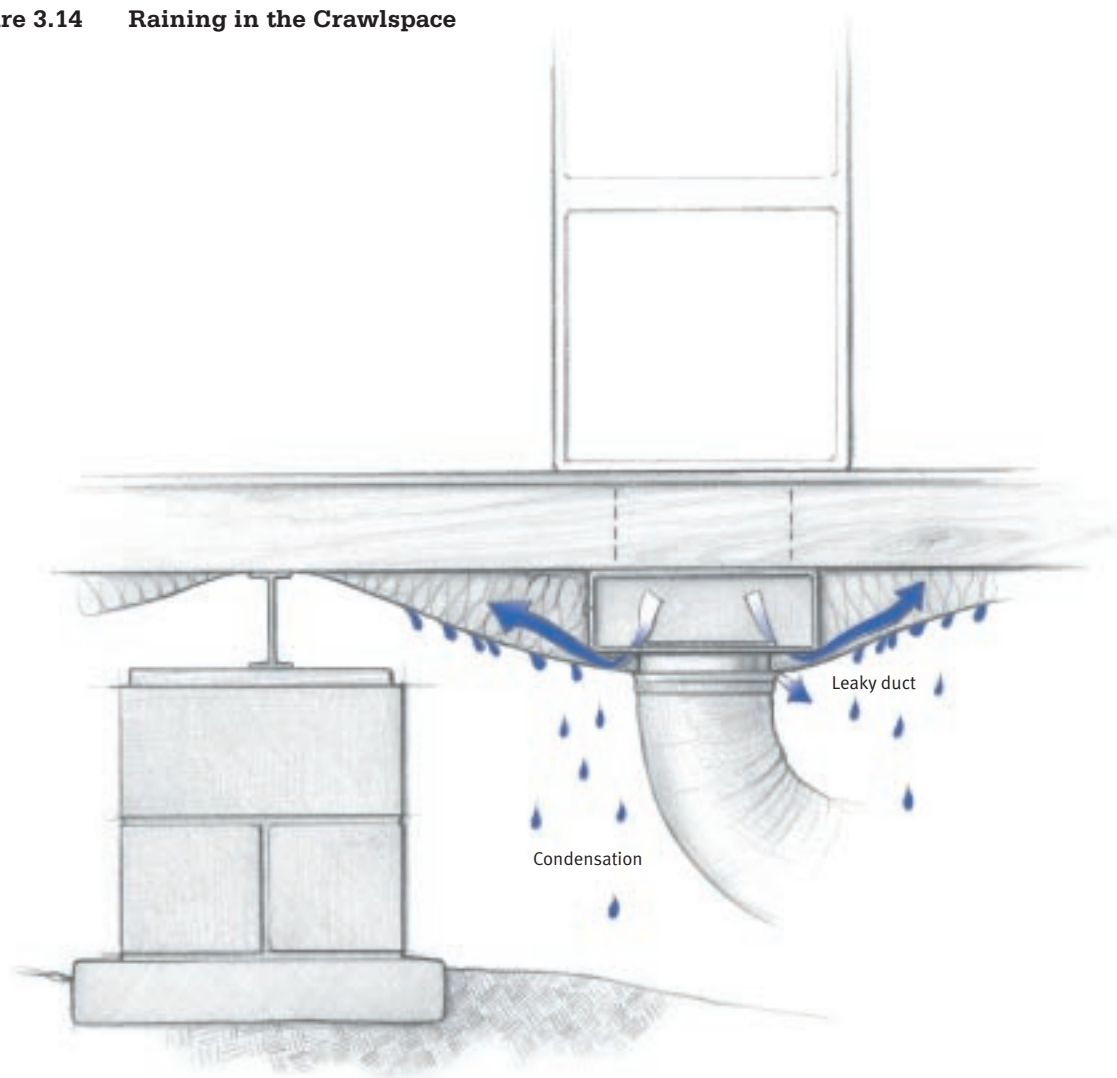

Duct leaks can cause water to "rain" into the crawlspace. Cold air that leaks from the underfloor duct system cools the belly material, supporting the condensation.

Moisture Problem Case Study: DRYER HOSE TORN FROM SKIRTING

- Season:** Winter
- Symptom:** Extreme condensation in crawlspace. Dryer hose torn from the skirting.
- Cause:** A six-foot long dryer exhaust hose made of uninsulated plastic was installed from the belly to outside the skirting. It was attached with tape and screws, but without support for the length of the hose. The cold air of the crawlspace causes damp air from the dryer to condense and build up inside the sagging hose. The weight of the water eventually ripped the hose away from the skirting.
- Remedy:** Drain and reattach dryer hose to skirting. Install supports for the hose along its length, and slope the hose toward the outside so any water condensing in the hose drains outside the crawlspace. Insulate the dryer hose to minimize condensation.

Moisture Problem Case Study: RAIN WASH UNDER HOME

- Season:** Summer and winter
- Symptom:** Once-even floors going out of level with visible sagging of the home and cracks appearing in the wall board.
- Cause:** Home site poorly graded, allowing runoff from rain to flow through the crawlspace. Water accumulation under the home made the soil wet so that its weight-bearing ability decreased, allowing the piers to settle.
- Remedy:** Properly grade the site to shed water away from the foundation area. Let the ground dry out and then re-level the home.

AIR DISTRIBUTION SYSTEM

There are three main types of supply ducts in manufactured housing: metal ducts enclosed in insulation, rigid fiberglass duct board, and flexible insulated ducts. Each type of duct is insulated to reduce heat loss or gain into the attic cavity or floor system. In homes with central air conditioning, good duct insulation is also essential to prevent moist air from condensing on the outside surface of the cold ducts.

Wet and damp ducts are linked to many building moisture problems. Ducts have cool, dark interiors with high relative humidity and offer an ideal environment for mold growth. Water can get into ducts and collect at low spots through condensate pan overflows or other spills that find their way into the air distribution system. A flooded duct can readily overwhelm the dehumidification capacity of an air conditioner, raising the relative humidity of the home and initiating mold growth throughout the interior. Standing water trapped within duct systems can foster bacteria, particularly in the heating season. The water will remain in the duct until it evaporates back into the distribution air stream, leaks out of the duct system, or until it is physically drained. If the flooding continues, the duct may never dry out. With extreme flooding, the added weight of the water can damage or entirely collapse the duct system.

When a metal duct system is exposed to moist crawlspace air through openings in the belly, it becomes a site for condensation. Water that condenses on the metal duct exterior is absorbed by surrounding materials, thereby compromising the material properties, degrading the surrounding insulation, promoting mold, and potentially causing duct joint failures.

Moisture Problem Case Study: FLOODED DUCTS

Season: Summer

Symptom: Moldy odors are present when the air conditioner is running. The system is cooling but the indoor humidity is high. There are no plumbing leaks or other sources of water intrusion, and no standing water under the home.

Cause: Water intrusion into the packaged air conditioning unit's main supply and return ducts. The packaged unit is contained in a metal cabinet adjacent to the home and is connected to the home by the supply and return ducts. Heavy rain occasionally floods the area around the packaged unit and then drains into the soil. The water leaks through the access panel seams to accumulate in the main ducts.

Remedy: Drain the standing water out of the ducts. Replace the ducts if there is mold on the inner liner or if the insulation layer is wet. Raise the unit off the ground by placing it on a platform.

Figure 3.15 Flooded Ducts

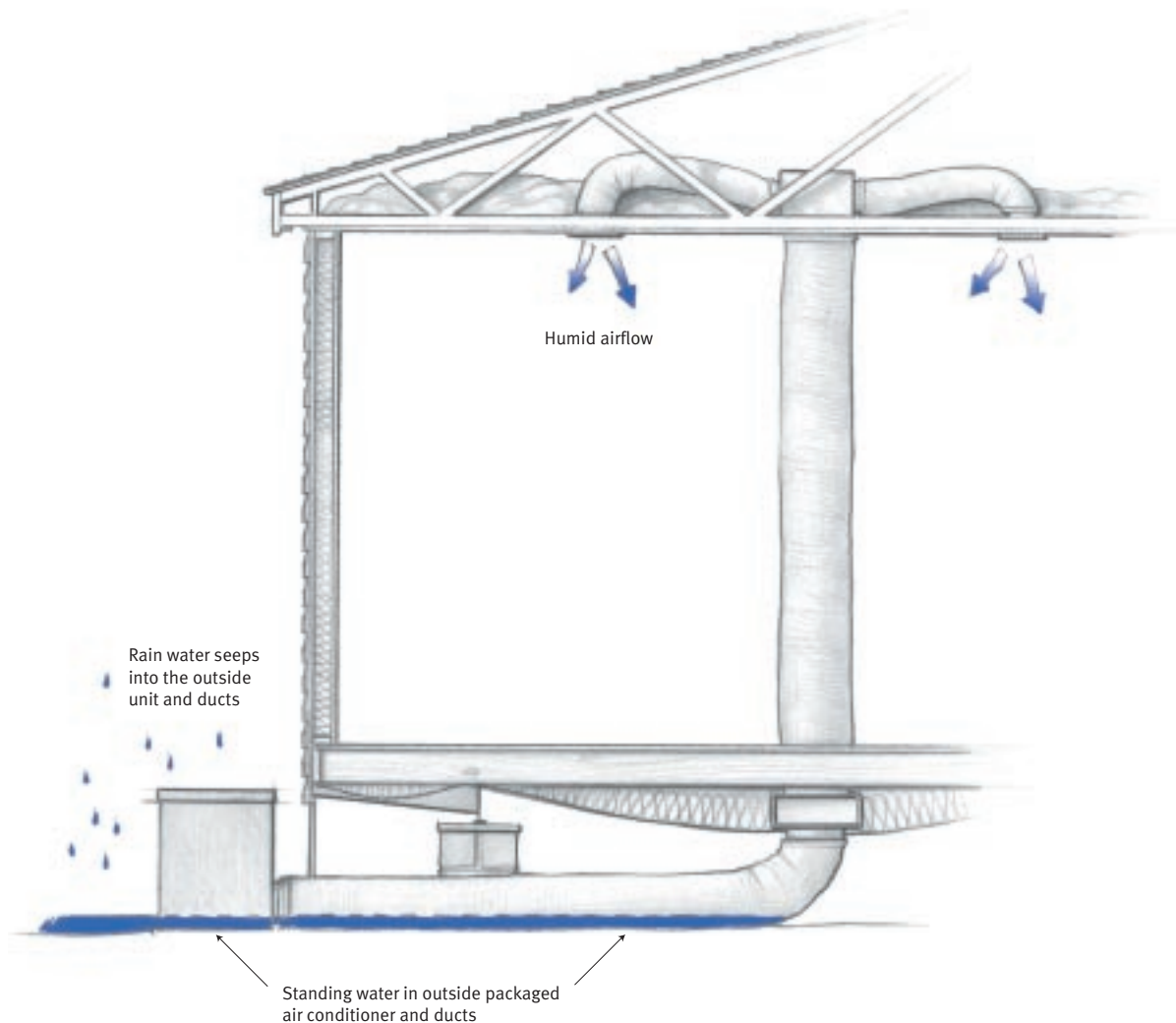

Heavy rains may drive water into the outside air conditioner's main supply and return ducts. When the air conditioner runs, moist air and often moldy odors are the result.

Moisture Problem Case Study: WATER IN CROSSOVER DUCT INSULATION

- Season:** Summer
- Symptom:** Very little airflow on one side of a double-section home when the air conditioner is running. The air conditioner worked fine when the home was new.
- Cause:** The flexible crossover duct system uses a metal boot to connect the "offset" furnace to the two supply trunks. The boot was not insulated, and water condensing from the crawlspace on the cold metal boot drained into the flexible duct insulation layer. The water built up until its weight kinked the duct and severely restricted air flow to one side of the home.
- Remedy:** Add an additional insulation vapor and retarder wrap to provide thermal and condensation protection for the exposed metal boot. Replace the saturated crossover duct.

Figure 3.16 Water in Crossover Duct Insulation

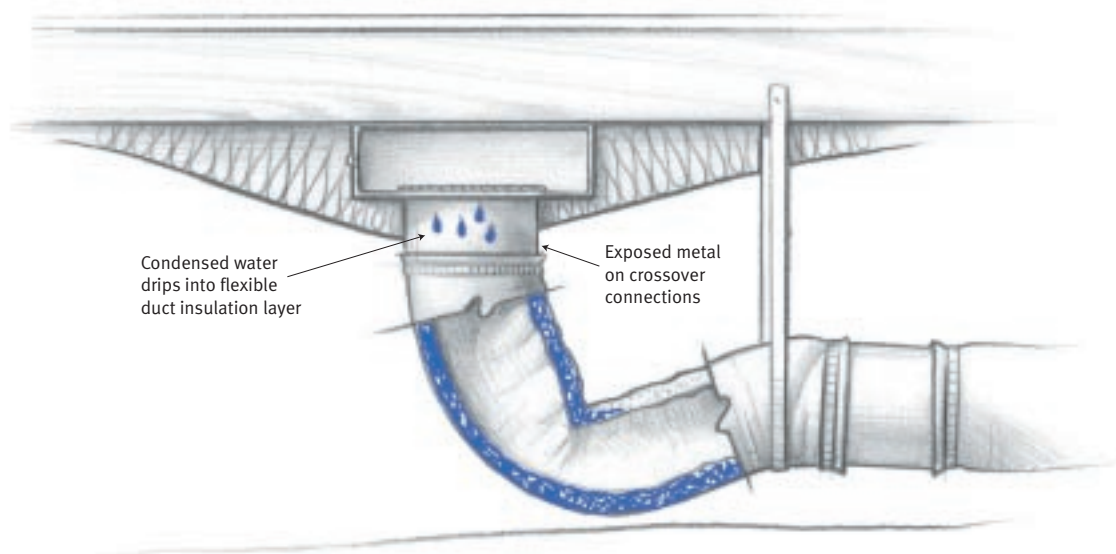

Exposed metal on crossover connections condenses water that can seep into the flexible duct insulation layer. The water builds up until its weight kinks the flexible duct, restricting airflow.

CLIMATE CONTROL AND AIR MOVEMENT

Air temperature, velocity, and quality are all obvious contributors to indoor comfort, but relative humidity (moisture level) is often overlooked. Most people consider indoor air comfortable if the relative humidity is between 30% and 60%. Complaints of discomfort—feeling hot and sweaty or feeling clammy at normal room temperatures (between 72°F and 82°F)—should be taken seriously and may be an early warning of moisture problems severe enough to cause damage. Moisture levels are generally higher in homes during peak heating and cooling seasons when:

- Occupants keep windows closed;
- Ventilation fans are not used (heating climate), are overused (hot, humid climate), or are broken;
- Exhaust fan ducts or the dryer hose is constricted, blocked, or does not vent to the outside; and/or
- The cooling system does an ineffective job of lowering humidity.

While it is possible to measure the relative humidity of a home, it is important to consider that a home's relative humidity will vary by 10% or more as equipment cycles on and off. During periods when the equipment runs less (e.g., an air conditioner runs less in the evening than during the day), the humidity level indoors will drift toward that of the outdoors. To complicate matters further, depending on the air conditioner's effectiveness and moisture removal capability, and the home ventilation system, the relative humidity for any particular home can vary considerably throughout the day.

A relative humidity over 70% is sufficient to support mold and mildew as well as to aggravate asthma and allergies. A home is considered to have excessive humidity if it reaches the 70% or higher level for even a portion of the day. Homes with such excessive humidity must reduce their sources of water vapor or increase water vapor removal. The latter is achieved by operating a properly sized air conditioner or other dehumidification equipment (in cooling season) or by increasing ventilation (in heating season).

Under the mistaken impression that bigger is better (i.e., more effective), many homes have larger-than-necessary air conditioners. Oversizing, in fact, reduces an air conditioner's dehumidification effectiveness because dehumidification is a function of how long the equipment runs. Oversized equipment cools the air quickly, but too quickly to provide significant dehumidification, resulting in a home that is cool but damp and often uncomfortable. The typical homeowner response is to lower the thermostat further. It is not uncommon to find setpoint temperatures lower than 70°F in this situation. In some regions, such indoor temperatures will support the condensation of water within wall cavities.

Some homes gain excess moisture through their fresh air ventilation system. This is particularly a problem for homes in humid climates whose outdoor ventilation intake is connected to the air handler in such a way that it bypasses the cooling (and dehumidifying) air conditioning coils. Ironically, ventilation requirements intended to increase indoor air quality and remove moisture during the cool periods can have the exact opposite effect in humid climates—increasing humidity to the home and increasing the likelihood of mold growth.

MOLD, MILDEW, AND MICROBES

Mold and mildew are simple plants that grow on material surfaces. Mold can cause stains, create odor problems, deteriorate materials, and prompt allergic reactions in susceptible individuals. To flourish, mold needs a nutrient base (most surfaces contain sufficient nutrients), moderate temperatures (between 40°F and 100°F), and relative humidity in excess of 70%. Because air at a lower temperature cannot hold as much water, colder rooms have a higher relative humidity. It is common for mold to first show up at cold spots that develop because of inadequate insulation and relatively still air. These cold spots become more humid than other areas and support more active mold growth.

Mold and mildew problems are related to high humidity throughout a home, however, it is common to find mold and mildew in only localized areas where conditions are prime to support their growth. Isolated cold spots on walls and high-moisture areas such as bathrooms are examples of these sites, particularly bathrooms with underutilized ventilation fans.

Moisture Problem Case Study: CLOSET MOLD

Season:	Winter
Symptom:	Mold growing on the interior surface of a closet.
Cause:	A closed closet door prevents heat from the home from entering the closet and warming the exterior wall. Cool temperatures and little air movement yield a relative humidity of over 70% in the closet. Stored clothes further prevent even minimal warming of this wall.
Remedy:	Advise homeowner to avoid stacking clothing against the exterior wall and to increase ventilation in the closet by leaving the door open.

Moisture Problem Case Study: CLOSED-OFF ROOM

- Season:** Winter
- Symptom:** Mold growing around windows and along the top of walls in a room that is seldom used and kept closed off from the rest of the home.
- Cause:** Little-used guest room was closed off for winter, including shutting the heating supply duct. The quantity of moisture in the guest room air is the same as in other rooms of the home, but its lower temperature makes for higher relative humidity and an ideal environment for mold growth.
- Remedy:** Advise homeowner to resume conditioning the room—and to seek other strategies for reducing the home energy bill.

Figure 3.17 Closed-Off Room

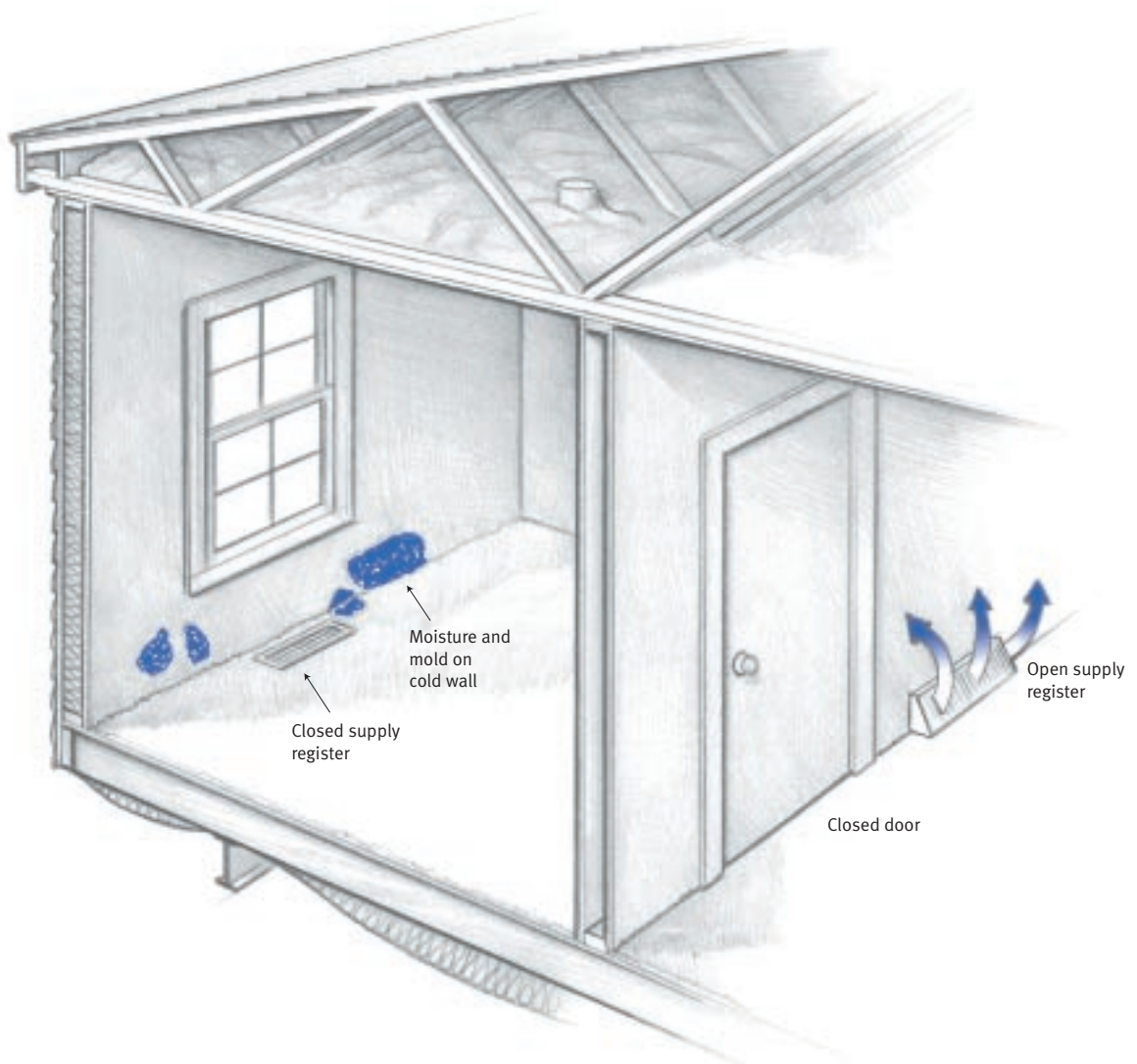

When the supply grilles are closed, warm air cannot enter a closed-off room. The inside air will become cold enough to significantly raise the relative humidity level in the room, supporting mold growth.

MOISTURE PROBLEM BASICS

All moisture problems share the same components: a moisture source, a mode of moisture transport, and a moisture accumulation site. This chapter explains each of these components, how their interactions can lead to problems, and how understanding them can point to solutions.

The physical properties of water allow it to move about very easily; in most cases, this acts to reduce moisture problems. If water is spilled on a floor, for example, gravity spreads the water over a wide area; water is molecularly attracted to most materials and it therefore tends to spread out and move away from a spill site. The net effect is greater water-to-air contact, which, because water has also a high vapor pressure, results in quick evaporation. This tendency of water to dissipate is a natural safeguard that helps protect homes from serious moisture damage. Most building materials can tolerate occasional wetting—as long as they are given the opportunity to dry out; this is the essence of the home "moisture balance." Each building material has a specific tolerance for wetness and can accumulate (store) moisture until this tolerance level is reached; above this level, the material fails to function properly and may deteriorate. Research indicates that materials absorb moisture faster than they release it; thus, more time is needed to dry a material and prevent continued accumulation. Any factor that increases the moisture added to a building material or decreases the speed at which it is removed can cause moisture to build up in amounts that can damage a home.

Figure 4.1 Moisture Balance

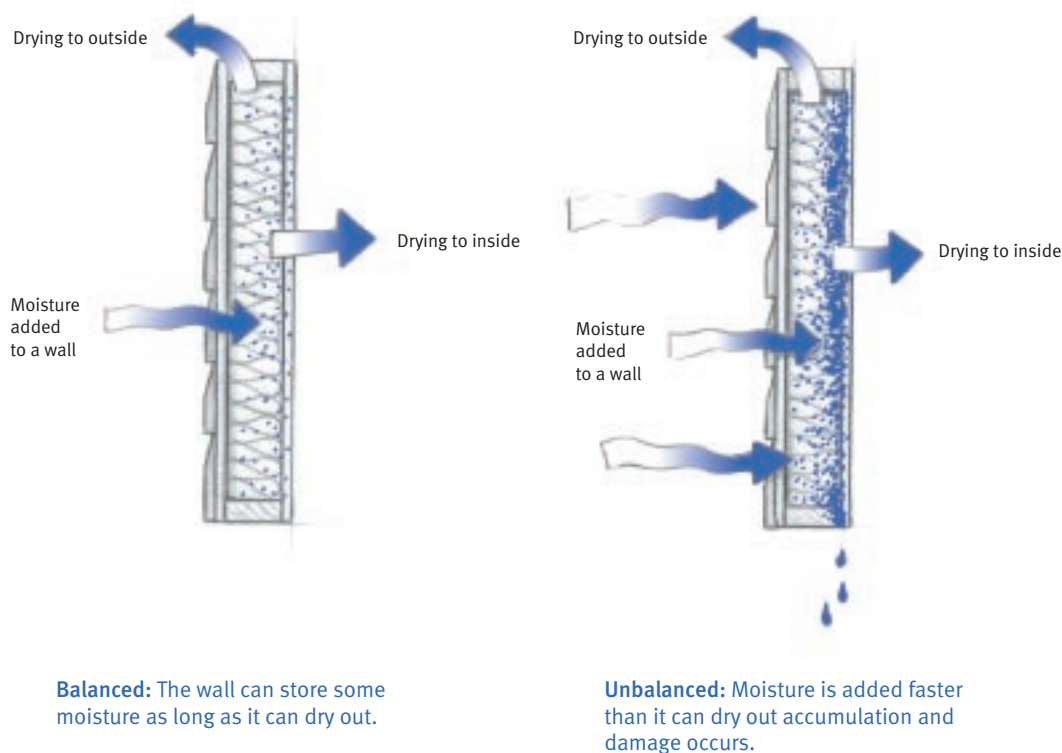

MOISTURE SOURCES

One of the keys to managing a moisture problem is determining the origin of the moisture. Once a source is identified, it may be possible to control, if not eliminate it, altogether. Rain, for example, cannot be prevented, but it can be kept out of attics and walls where it can cause damage.

The sources of excess moisture in homes can be quite varied. The ground under most homes has high moisture content. Even when it appears dry, it can contribute significant water vapor to a home. Likewise, the outside air contains moisture, especially in humid climates; under some conditions water vapor from outside air will contribute to problems inside a home or its building components. Everyone knows that plumbing fixtures contain water, but other household equipment contains water as well: air conditioners, refrigerators, washers, and even clothes dryers

can be the source of damaging moisture if they are not properly maintained. One source of moisture that is recognized and discouraged by many home manufacturers is unvented space heaters. Although such heaters are claimed as "clean burning," no one denies that water vapor is given off during operation—about a gallon of water for every gallon of fuel consumed. Even moderate use of unvented combustion heaters can be a significant source of problem moisture.

In many climates, rain and snow are persistent in challenging a home's defenses. Every imperfection in the increasingly complex outer shell of a home is a potential entry point for these water sources.

People and their activities are another source of moisture. Although the average person does not usually add enough moisture to cause a problem, excessive activity—for example, keeping 15 or more indoor plants, or an extended period of steam cooking—can upset the moisture balance. Other people-related sources of moisture include the storage of damp materials in the home (e.g., firewood), and showering without using the bathroom fan. Many moisture sources are subtle and require some experience or training to locate. Identifying the source(s) is the first step to eliminating or managing damaging moisture accumulation.

Figure 4.2 Moisture Production from Indoor Activities

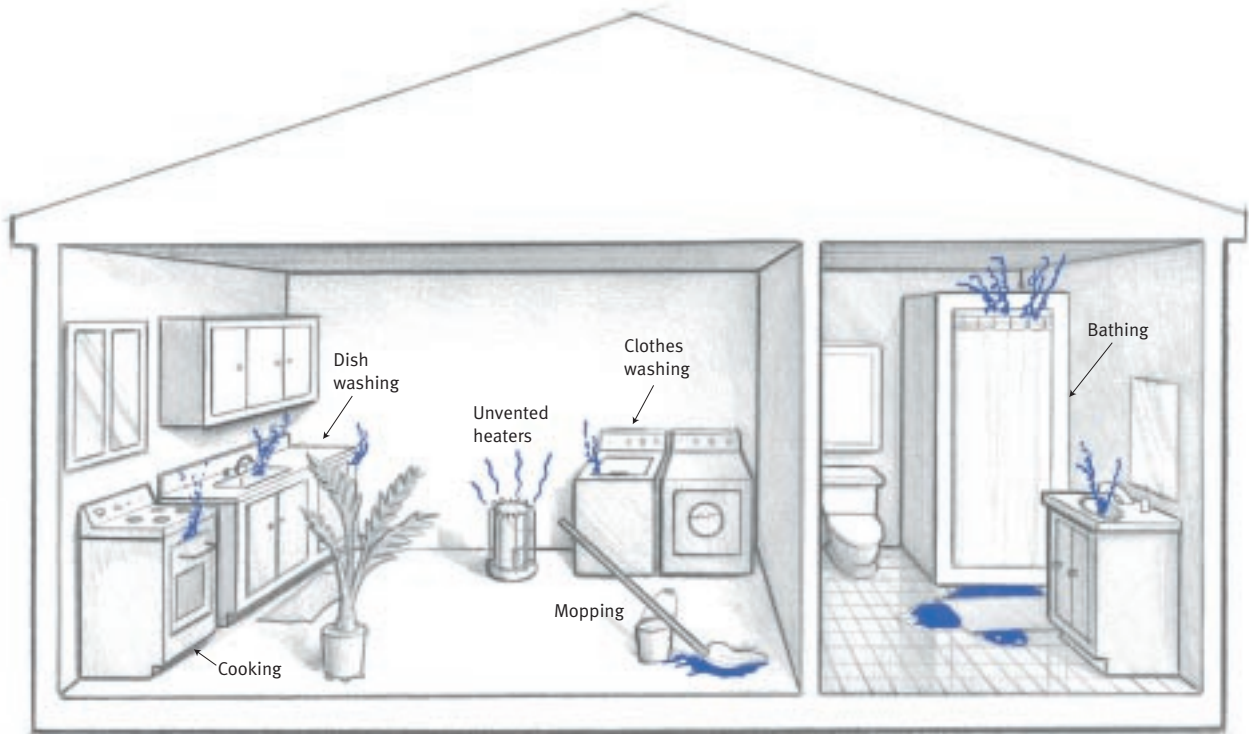

Domestic sources of moisture include bathing, showering, cooking, mopping, and clothes washing and drying. The more problematic indoor sources are unvented gas appliances, indoor gardens, saunas, hot tubs, and indoor storage of firewood.

Figure 4.3 Sources of Moisture

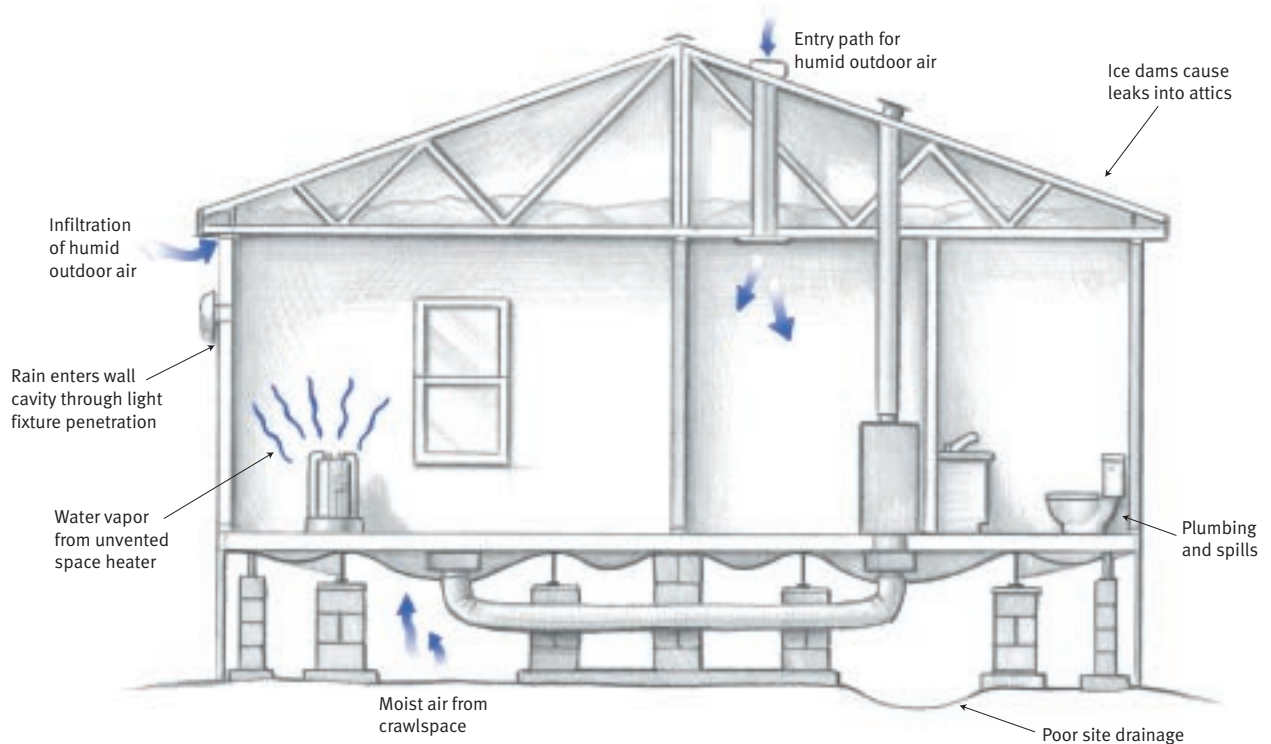

Identifying the source of moisture is the first step to eliminating or managing the problem.

MOISTURE MOVEMENT

Water moves from one place to another as it seeks "equilibrium" in its surroundings. Water has several paths of movement within a building and sometimes uses several paths at once. Liquid flow, capillary action, and air movement are some of the important ways that water moves.

Liquid flow: Gravity causes liquid to flow downhill. Sometimes this movement is simple, such as when water condenses on a window pane and flows down onto the sash. Sometimes the movement is more complex, such as when water collects in an attic and flows horizontally along the sheathing, eventually making its way into a wall where it shows up as a stain on an interior wall, floor, or ceiling.

Capillary suction: Porous materials such as wood, wall board, or concrete block, and materials that are sandwiched together, such as shingles or flashing, often act like sponges, bringing water uphill against gravity. This is what is happening when a puddle touching a wall leaves stains on the wall far above the floor level.

Air movement: After liquid flow, air movement is the most important of the moisture movement mechanisms. The movement of air can be the result of several driving factors: exterior wind speed, negative and positive pressure inside the home (see **Mechanical equipment operation** on page 4.4), and stack effect (hot air rises because it is less dense). The rate of air movement through the envelope of the home depends on these factors acting simultaneously. For example, on a windy day with the thermostat set to cool the home, there will be significant combination of pressures pushing outside air into the home. Holes in the envelope are natural pathways for air movement. For example, if there are gaps in the marriage line gasket, air can be exhausted through openings in the ceiling gasket with makeup air drawn from the moist crawlspace, transporting unwanted moisture into marriage wall cavities where it can cause damage or enter into the home.

Figure 4.4 Moisture Movement

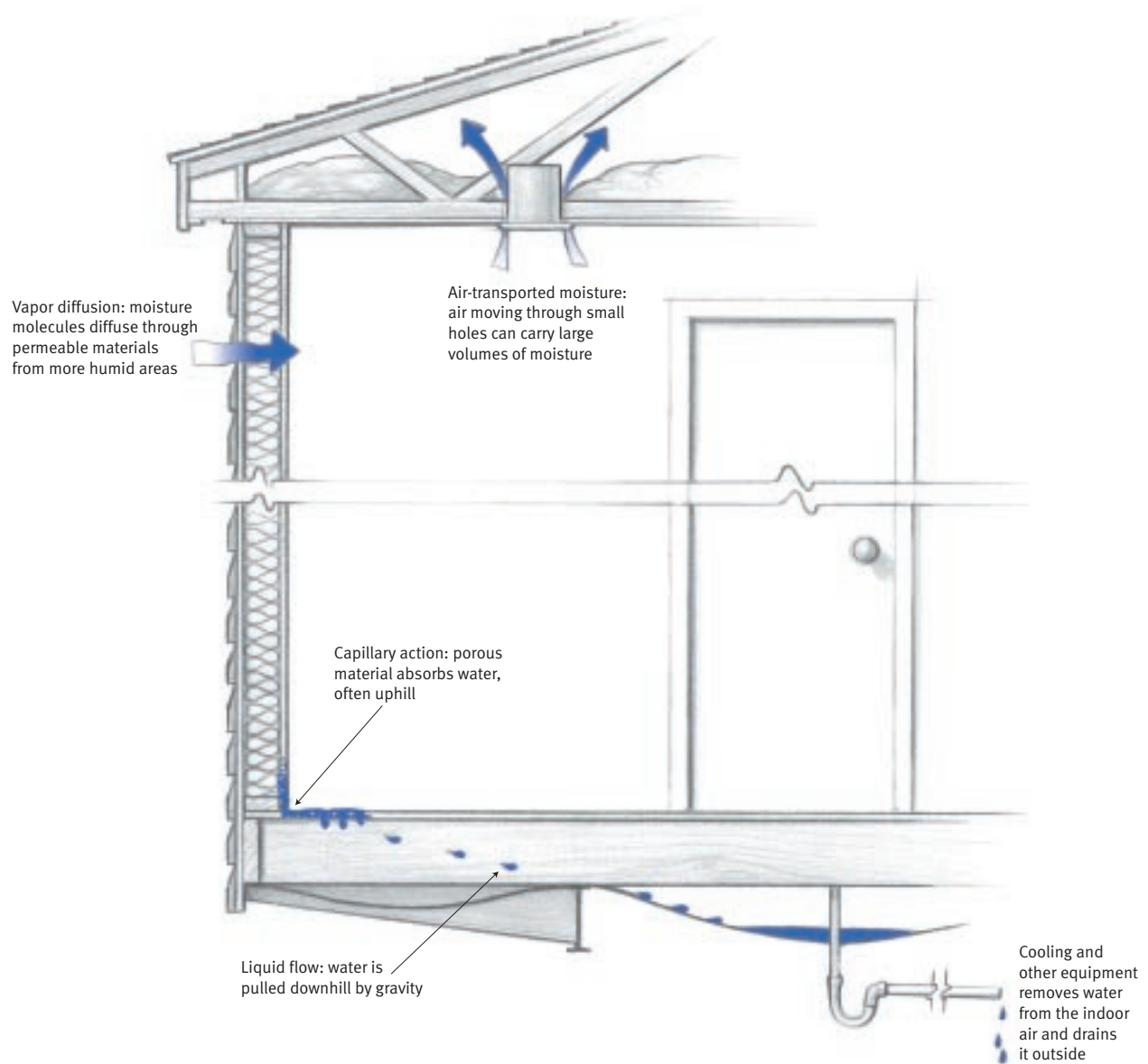

Water moves from one place to another via liquid flow, capillary action, vapor diffusion, air movement, and equipment operation.

Vapor diffusion: Even where there is no air movement, water vapor migrates to areas where it is less concentrated. This property, vapor diffusion, causes water molecules to move through materials such as wall board. Vapor retarders, such as "low-permeability" paints, resist this molecular movement and can minimize moisture movement caused by vapor diffusion.

Mechanical equipment operation: Dehumidifiers and humidifiers are designed to remove or add moisture to a home's indoor environment. Air conditioners are quite effective dehumidifiers if properly sized and charged. Air conditioner-based dehumidification is a function of equipment run-time; the longer a system operates, the more water vapor it removes. Oversized air conditioners are poor dehumidifiers. Since the thermostat that controls a cooling system is triggered only by air temperature, an oversized air conditioner cools the air quickly but may not run long enough to sufficiently dehumidify the air.

MOISTURE ACCUMULATION

Moisture in a home has many sources and can move in many ways. It becomes a problem only when it stops moving and accumulates. Moisture damage occurs when the amount of moisture accumulated exceeds the moisture storage tolerance of a specific building component—from the roof sheathing to the wood window sash or wall and floor cavities. Each of these sites will experience problems if moisture is added faster than it can be removed.

Figure 4.5 Moisture Accumulation

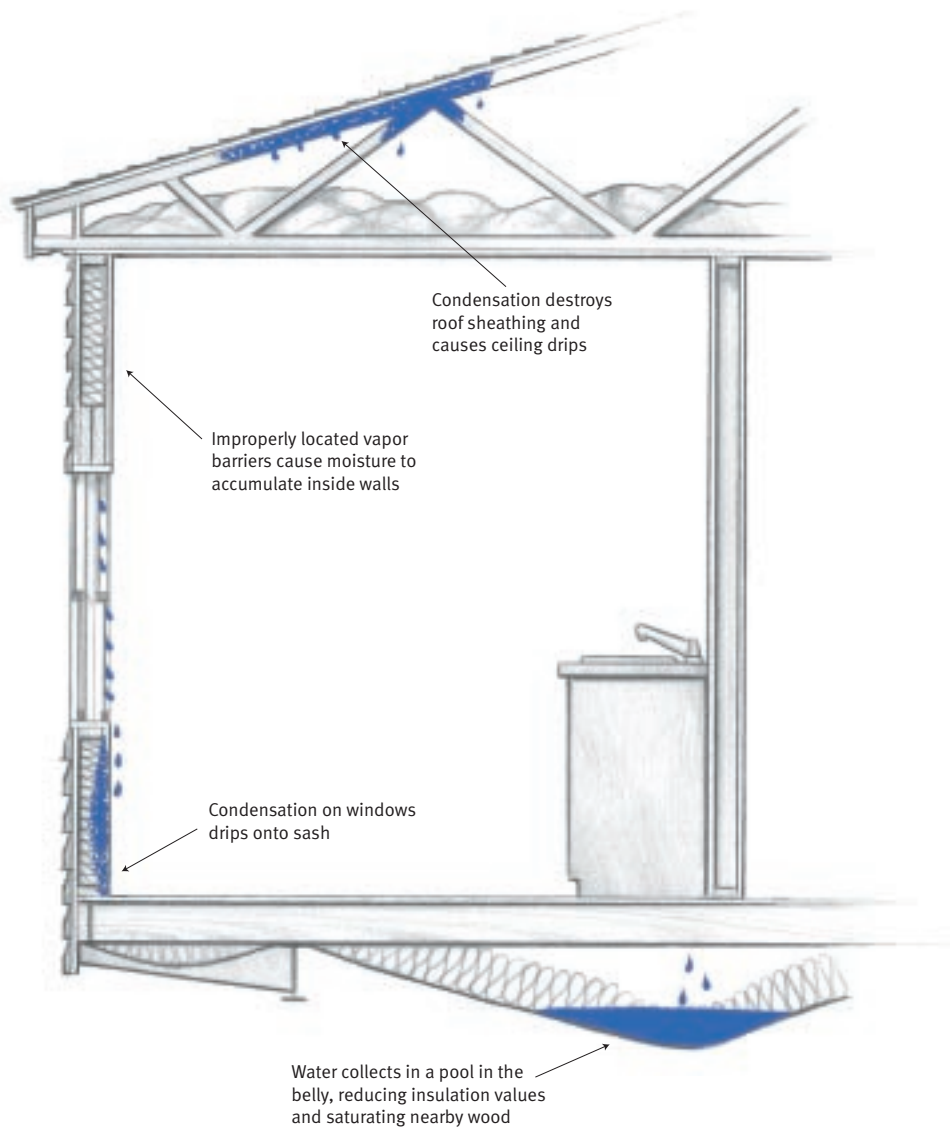

Moisture in a home becomes a problem only when it stops moving and accumulates in damaging amounts.

Water moving by gravity flow eventually finds a low spot, such as the belly of the home, where it can flow no further. This is the simplest illustration of accumulation. The materials in the floor system can tolerate this condition for a short period of time; however, if the water remains, mold will grow, the wet insulation will lose its thermal resistance capacity, and the wooden floor frame will swell and eventually rot.

Summertime moisture damage is increasingly occurring inside wall cavities: when the indoor temperature is low because of air conditioning, moisture accumulates by condensation on the backside of the wall board. The use of a vapor retarder on the inside of exterior walls in hot, humid climates limits the ability of these walls to dry out, setting up conditions for mold and structural damage inside the wall cavity.

SOLVING MOISTURE PROBLEMS

The key to solving moisture problems is to understand:

- Why moisture has accumulated at the damage site,
- Where the moisture is coming from, and,
- When the source of the damage is physically removed from the site of the damage, how the moisture traveled from one place to the other.

In many cases, altering just one of these elements is enough to solve a specific moisture problem. More often, remedying moisture problems poses quite a puzzle, especially if multiple sources and transport methods are involved, or if the moisture source is far removed from the site where damage is manifested. Fortunately, effective moisture control can be achieved consistently and is the result of good design, careful installation, and intelligent home operation.

air retarder

A material or system designed and installed to reduce air leakage into or through the exposed areas of a wall or other building components that enclose conditioned space.

bottom board

Most commonly a flexible sheet material that is used to enclose the bottom side of the floor system from the crawlspace. Also referred to as the "belly."

capillary action

Uphill movement of water against the force of gravity into porous materials such as brick, wood, and wall board due to the relative surface attraction between the molecules of water and the solid.

condensation

A process in which water vapor changes into liquid water by the extraction of heat from the vapor.

convective loops

Convection is the transfer of heat through the movement of air. When convection occurs in a closed cavity, such as inside a wall, the air movement forms a loop—moving up one side of the wall and down the other. This is a moderately effective way of moving heat and can defeat insulation effectiveness.

dehumidification

The removal of water vapor from air by either cooling the air below the dew point and draining the resulting liquid away, or by absorbing it from the air through a repeatable chemical process.

dew point

The temperature at which humid air becomes saturated and the water vapor begins to condense to liquid water.

duct leakage

Air leakage from holes, faulty seams, rips, and tears in the heating and cooling air distribution system.

dust mites

Microscopic insects that grow in carpets, upholstered furniture, and mattresses when the relative humidity levels reach 50%. Many people are allergic to the fecal matter produced by dust mites.

exfiltration

The uncontrolled flow of air out of a building through cracks, holes, doors, or other openings that allow air to escape. Air that leaks out of a home is replaced by outdoor air that is brought in by fans or infiltration. (See infiltration.)

infiltration

The uncontrolled flow of air into a building through cracks, holes, doors, or other openings that allow air to move in from the outside. (See exfiltration.)

insulation

A building layer that has a high resistance to heat flow in and out of buildings. Common insulation materials used in manufactured housing are cellulose, fiberglass, and rock wool.

latent heat

Heat given up when a substance changes from vapor to liquid. Although heat is removed, the substance stays at the same temperature while condensing.

marriage line

The line of intersection through the floor, walls, ceiling, and roof that joins two home sections together.

MHCSS (Manufactured Home Construction and Safety Standards)

A set of specifications to which manufactured housing manufacturers must build. This is a comprehensive national standard administered by HUD; it preempts all other building regulations. Also referred to as the "HUD-code."

moisture and vapor retarder

Materials used to slow the passage of water vapor or moisture into building assemblies through diffusion.

mold and mildew

Fungal colonies that grow on surfaces when the relative humidity is 70% or higher and a nutrient or food source is available, such as the cellulose fibers in the paper finishes of wall board. Mold spores are allergens that can emit odors and make stains, and are associated with respiratory symptoms in sensitized individuals.

permeance

A measure of the ability of a material to transmit free water molecules by diffusion. The term "perm" is the rate of water movement through a material.

perm rating

A measurement of the amount of molecular diffusion of water through a given material. HUD-code-required vapor retarders usually have a perm rating of less than 1.0. Typical vapor retarders include polyethylene sheets, special interior paints, and the vinyl finish on wall board.

pressure balance

Air movement is caused by pressure imbalance. Air always moves from high pressure to low; if there is a pressure balance, air will not move. Pressure balance in a home keeps air from moving into undesirable places such as into building cavities.

relative humidity (RH)

The ratio of water vapor in the air to the amount the air could potentially hold at a given temperature.

skirting

A perimeter enclosure that creates the crawlspace area under a manufactured home. Skirting materials range from ventilated vinyl siding to brick walls.

stack effect

A pressure difference that exists because of the temperature difference of the air masses inside and outside a building. In winter conditions this pressure difference causes airflow into a building at its lower levels and out at its higher levels.

thermal barrier

A continuous blanket of materials (such as fiberglass insulation) used to slow the flow of heat into building assemblies.

vapor diffusion

The movement of water vapor from a region of high concentration to a region of low concentration.

vapor retarder

Material used to slow the passage of water vapor into building assemblies; usually a sheet or coating with low permeance. Also referred to as "vapor diffusion retarder."

ventilation

The introduction of outdoor air into a building. Passive ventilation takes place naturally through windows, doors, and air leakage sites. Mechanical ventilation uses a fan to move air. Mechanical systems that use exhaust fans depressurize a home, whereas systems that bring in ventilation air with the furnace fan pressurize a home. Spot ventilation is the temporary use of bath and stove exhaust fans to remove odors and water vapor.

wall, ceiling, and floor cavities

Spaces between the outside sheathing and the inside surface treatment; usually containing insulation, ductwork plumbing, and electrical wiring.

BIBLIOGRAPHY

- Burch, M. Douglas. 1995. *An Analysis of Moisture Accumulation in the Roof Cavities of Manufactured Housing*. STP 1255. Philadelphia: American Society for Testing and Materials: 156–177.
- Cutter Information Corporation. 1986. "Moisture in Houses—Control Technology for Designers and Builders." New York.
- Elovit, Kenneth M. 1999. "Understanding What Humidity Does and Why." *ASHRAE Journal*, Vol. 41, No. 4 (April): 84–90.
- Lstiburek, Joseph and John Carmody. 1991. *Moisture Control Handbook: New, Low-Rise Residential Construction*. Washington, D.C.: U.S. Department of Energy Conservation; Renewable Energy Office of Buildings; Community Systems Building Systems Division.
- Manufactured Housing and Standards Division and The National Conference of States on Building Codes and Standards. 1998. *The Essentials of Moisture Control Through a Building Envelope*. Washington, D.C.: U.S. Department of Housing and Urban Development (February).
- Proctor, John, Zinoviy Katsnelson, and Brad Wilson. 1995. "Bigger Is Not Better—Sizing Air Conditioners Properly." *Home Energy Magazine*, Vol. 12, No. 3 (May/June): 19–26.
- Oak Ridge National Laboratory, Building Technology Center. 1996. *Moisture Control in Walls, Version 1.0* [computer software].
- Swinton, M.C., W.C. Brown, and G.A. Chown. 1999. "Small Buildings—Technologies in Transition: Controlling the Transfer of Heat, Air, and Moisture Through the Building Envelope." *Building Science Insight Series*. NRCC 3233. Ottawa, Canada: National Research Council Canada.
- Tang Lee Environmental Design. 1984. *Condensation in Manufactured Housing*. Alberta, Canada: The University of Calgary.
- TenWolde, Anton. 1993. *Ventilation, Humidity and Condensation in Manufactured Houses During Winter*. Washington, D.C.: U.S. Department of Agriculture, Forest Service Forest Products Laboratory.
- TenWolde, Anton, et al. 1993. *Air Flows and Moisture Conditions in Walls of Manufactured Homes*. Washington, D.C.: U.S. Department of Agriculture, Forest Service Forest Products Laboratory.
- Tsongas, George. 1995. "Moisture and Mobile Home Weatherization." *Home Energy Magazine*, Vol. 12, No. 4 (July/August): 29–31.
- U.S. Department of Commerce. National Institute of Standards and Technology. 1997. *MOIST-A PC Program for Predicting Heat and Moisture Transfer in Building Envelopes (Release 3.0)* [computer software]. NIST Special Publication 917 (September).
- U.S. Department of Commerce. National Institute of Standards and Technology. 1996. *Mathematical Analysis of Practices to Control Moisture in the Roof Cavities in Manufactured Homes*. NISTIR 5880.
- U.S. Department of Commerce. National Institute of Standards and Technology. 1995. *Manufactured Housing Walls That Provide Satisfactory Moisture Performance in All Climates*. NISTIR 5558.
- U.S. Department of Commerce. National Institute of Standards and Technology. 1995. *Heat and Moisture Transfer in Wood-Based Wall Construction: Measured Versus Predicted*. NIST Building Science Series 173.
- U.S. Department of Commerce. National Institute of Standards and Technology. 1991. *Indoor Ventilation Requirements for Manufactured Housing*. NISTIR 4574.

U.S. Department of Commerce. National Institute of Standards and Technology. 1992. *Controlling Moisture in the Walls of Manufactured Housing*. NISTIR 4981.

U.S. Department of Commerce. National Institute of Standards and Technology. 1992. *Controlling Moisture in the Roof Cavities of Manufactured Housing*. NISTIR 4916.